



TM SHEA PRODUCTS
 IDEAS FOR SPACE IDEAS FOR SALES



IN THE AIR

OFF THE GONDOLA



ON THE FLOOR

3D

**In-Store
 Marketing &
 Merchandising
 Solutions**

8th Edition
37th Year Anniversary

New Profits. Made Easy. Right Now. Here's How!

We at TM Shea Products, Inc. are proud to introduce our new 8th edition, 37 year anniversary catalog featuring many new innovative designs. TM Shea Products, Inc. partners with retailers, wholesalers and CPG/brands to explore and share new creative and performance driven ideas, designs and strategies for in-store marketing/merchandising challenges and solutions.

In an industry with ever-changing needs we continually strive to create the perfect solutions for all types of POP merchandising scenarios, departmental store décor, way-finding and promotional sign systems.

- **POP Impulse Merchandising Displays**
- **Floor Merchandising Displays**
- **Store Décor, Wayfinding, Promotional Sign Holders**

We strive to assist our customers to increase sales and profits by providing durable innovative displays and sign systems with superior product quality, customer service and accurate on-time shipping. Our sales and service team encourage 'One-Stop Shopping' by offering design, development, engineering, photo comps, prototypes, production, sign printing, product pack-outs, 'kit' packing, warehouse and store drop shipments.

TM Shea Products has over 65 patents issued and over 100 patents pending. By combining these patented displays and sign systems you will increase your visual excitement, foot traffic, selling space, merchandising flexibility, new shopper solutions touch points, and sales. New profits. Made easy. Right now.

We look forward to assisting you with your instore marketing and merchandising challenges.

Sincerely,



Thomas M. Shea, President

800.992.5233 • email: hq@tmshea.com



Create A-Store-Within-A-Store

OFF THE GONDOLA

SwingStrips® get your products noticed. Designed for impulse and cross-merchandising, SwingStrips® are visually appealing, reload and shop easier than traditional merchandising strips methods; thereby selling products faster. Some retailers have experienced a sales lift of approximately 75% over plastic strip clips and/or J-hooks.

ON THE FLOOR

The PowerPillars™ offer a uniform look and flexible promotional floor merchandising. Their unique “lego-type-system” feature accommodates a variety of accessories for changing product schematics. The plan-o-gram, including graphics, can be changed with seasonal requirements or category strategies. These floor spinners are ideal for down aisle promotions, side of endcaps, perimeter drive aisles and check-out lane areas.

IN THE AIR

Our department overhead sign systems dress up your plan-o-grams to create an upscale shopping experience, more foot traffic and shopper activity. Overhead signs along with wayfinding category ArcArms™ help customers navigate through the store, highlight higher-margin departments and provide high visual impact. Department sales have increased 20-25% for some retailers.



Table of Contents

Gondola 8

Shelf SwingStrip®
10



Tri-Spinner Promo-Panels™
21



Wire Power-Wings™
36



Knee Knocker Racks
50



Wall Swing-Strips®
12



AMMOStrip®
22



Pegboard Wings™
38



SkyBar
51



Specialty SwingStrips®
14



Perma-Panels®
24



Basket and Bin Display
40



Bunker-Bridges
52



PocketStrip®
15

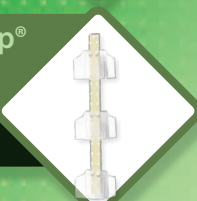

Promo-Panels
26



Security End Cap PowerWing
41



Lockable Security Cases
54



PowerStrips
16



Heavy Duty Promo Panels
28



Cooler/Freezer Door Display
42



Gondola Accessories
56



MagnaStrip®
18



PSE Cards & Display
30



SpeedStrip2™
44



Mini Power-Pillar™ Floor Spinners
60



PromoStrips
19

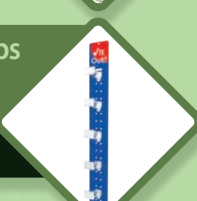

CBD Pocket Panels™
32



SpeedPegs
46



PowerPillar™ Floor Spinners
62



Greeting Card ArcArms™
20



Power-Towers™
34



SpeedBars™
48



Econo Power-Pillars™
64



Registered Trademarks:	1,291,902	1,486,886	2,318,359	2,307,273	2,318,358	2,737,852	2,889,581	2,743,940		
Issued Utility Patents:	4,627,128	4,780,172	5,666,732	5,660,286	5,957,422	6,199,706	6,070,747	6,202,866	6,390,337	6,536,613
	6,675,978	7,100,878	7,118,000	7,121,416	7,665,617	8,001,712	8,342,343	9,867,483	10,334,968	

On The Floor 58

In The Air 78

SideStackers™



65

Floor Display Accessories

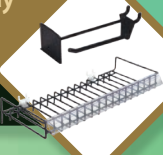

76

ClearView Sign Holders



94

Glass Door Suction Signs



103

Power-Grids™



66

End Cap Promo Signs

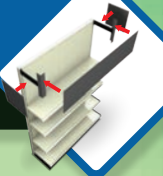

80

2 Sided End Cap Signs



95

ArcArms™ Double Hook

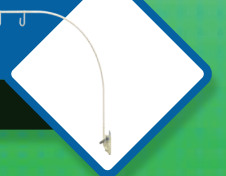

105

2 Sided Lockable Spinning Cases



68

Down Aisle Box Out Signs

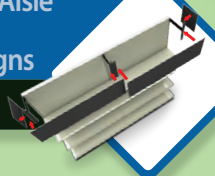

82

Blade Sign Holders



96

ArcArms™ Single Hook

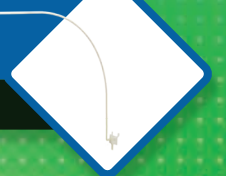

106

Rotating Floor Display



70

Top Rail Sign Channels



84

Vertical Sign Posts



97

Heavy Duty ArcArms™



108

Spinner Bucket Tree Display



71

Overhead Sign Systems



86

Plastic Crescent Signs



98

Magnetic ArcArms™



110

SpinStrip/Spin-Panels



72

Angled Overhead Signs



89

Shelf Sign Holders



100

Banner Sign Holders



111

TriSpinners



73

Ghost Brackets

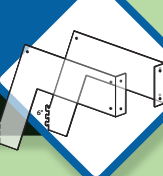

90

Wall Sign Holders

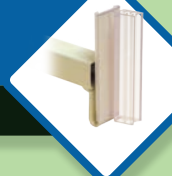

101

Create A Store...



112

QuadSpinner Floor Display



74

Flush Mount Signs



92

MagnaGrip & Magan-Brackets

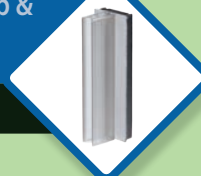

102

Issued Foreign Patents:	2,242,045									
Issued Design Patents:	422,483	422,886	423,857	424,767	432,844	435,381	435,435	455,067	457,364	457,365
	457,770	458,782	459,132	459,626	462,556	463,251	464,510	464,837	464,838	465,371
	465,372	466,352	467,114	468,948	469,629	471,044	476,217	477,769	483,656	505,615
	532,289	543,442	654,727	657,975	671,393	672,576	674,682	674,683		

The 'Systems Solutions' Approach

Evaluate

- Are you currently using traditional J-hooks and disposable plastic strips?
- Are your disposable plastic strips blocking product on the shelf?
- Are you making the most of all possible selling space?
- Do your displays provide continuity and are they easy to shop and reload?
- Are your aisles easy to navigate?
- Are your departments visually enhanced to increase customer foot traffic?

Strategize

- Determine the merchandising and sign systems that will work best for your store or brand.
- Identify key locations for displays and signs.
- Create graphics that offer a 'call to action', brand awareness or lifestyle imagery that matches your store decor.
- Review in-store photo comps created by our graphics department that superimpose our displays and graphics onto your plan-o-gram.

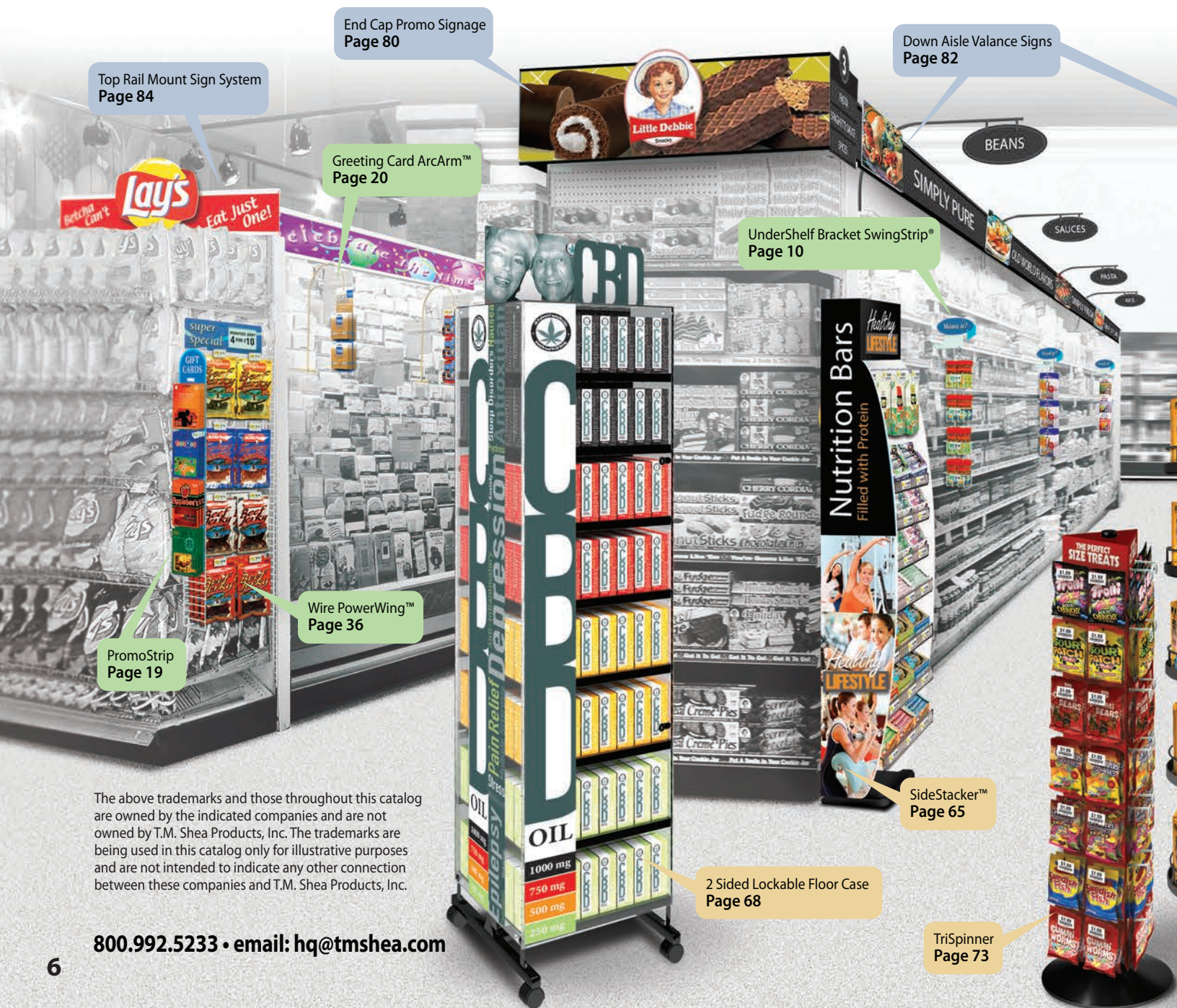

Top Rail Mount Sign System
Page 84

End Cap Promo Signage
Page 80

Down Aisle Valance Signs
Page 82

Greeting Card ArcArm™
Page 20

UnderShelf Bracket SwingStrip®
Page 10

Wire PowerWing™
Page 36

PromoStrip
Page 19

SideStacker™
Page 65

2 Sided Lockable Floor Case
Page 68

TriSpinner
Page 73

The above trademarks and those throughout this catalog are owned by the indicated companies and are not owned by T.M. Shea Products, Inc. The trademarks are being used in this catalog only for illustrative purposes and are not intended to indicate any other connection between these companies and T.M. Shea Products, Inc.

800.992.5233 • email: hq@tmshea.com

Test/Rollout

- Once a merchandising and in-store marketing strategy is developed, we can provide you with fixtures and prototype signs to rollout a department or store for testing.
- Installation can be performed by in-store personnel or a third party service.
- Track sales results and compare them to previous reports; let the numbers speak for themselves!

Profit

- You will find that turning your unused air space into "new profit centers" will dramatically increase your sales.
- Utilizing our displays for in-line and cross-merchandising significantly boosts promotional sales.
- Retailers can off-set fixture costs with vendor lease programs and placement fees.
- Our displays are very durable and offer both retailers and brand marketers a quick return on investment.



Double Hook ArcArm™
Page 105

End Cap Promo Signage
Page 80

Top Rail Mount Sign System
Page 84

PSE Flex Panel
Page 30

MagnaStrip
Page 18

PowerTower™
Page 34

Rotating Floor Display
Page 70

PowerPillar™
Page 62

Gondola Displays

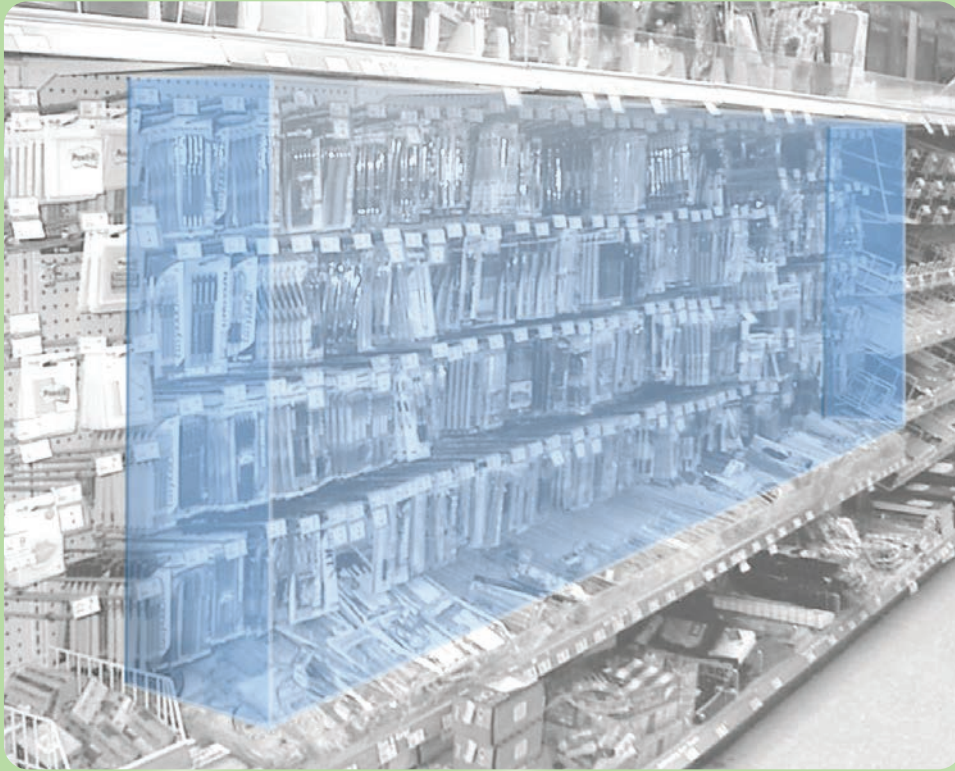

PROBLEM

Unused valuable selling space result in missed sales and profits.

EXAMPLE

22"	Base Deck
– 8"	Peghooks
14"	Unused Air Space

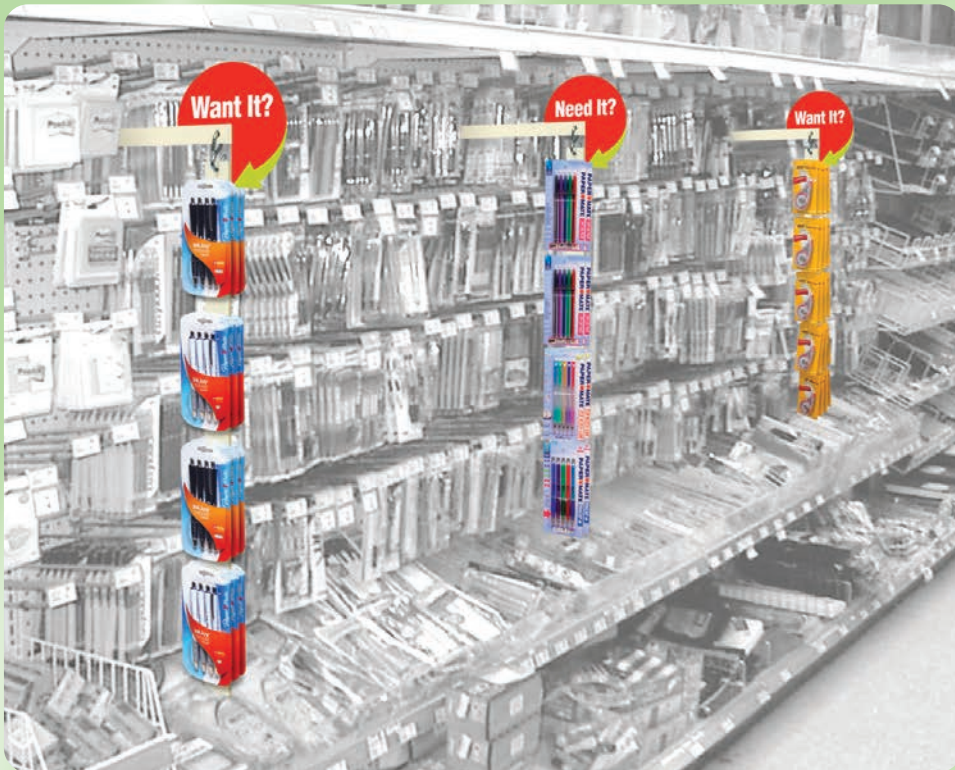

SOLUTION

Add gondola displays to:

- Expand selling space 10-40%
- Promote new products
- Increase foot traffic
- Raise sales per square foot

The above trademarks and those throughout this catalog are owned by the indicated companies and are not owned by T.M. Shea Products, Inc. The trademarks are being used in this catalog only for illustrative purposes and are not intended to indicate any other connection between these companies and T.M. Shea Products, Inc.



Off Shelf



Off Wall



End Cap Sides



More Selling Space for Retailers. More Impact for Brand Manufacturers

Our gondola displays take your products off the shelf and make them more visible to customers. Ideal for in-line and cross-merchandising, gondola displays capture unused air space and create new or promotional selling space. Whether you choose an off shelf, off wall or end cap application, each of our innovative patented displays provide a clean look that has been proven to be far superior to traditional J-hooks and disposable plastic merchandising strips. Many retailers and brand manufacturers view our programs as "best practices" for impulse and cross-merchandising. Retailers can create more selling space, and brand manufacturers have the opportunity to not only get their products in the store, but in front of the competition!

Shelf SwingStrip®



BEST SELLER



Plastic Off Shelf Bracket
PS-OSB2+(Color)



Metal Under Shelf Bracket for Standard Shelves
PS-USB5+(Color)



Metal Under Shelf Bracket for Shelf Management Systems
PS-USB6V1+(Color)



Metal 1 Bolt Under Shelf Low Profile Break Bracket
PS-USBB-LPA-I_+(Color)



Metal 1 Bolt Under Shelf Break Bracket
PS-USBB-I+(Color)



Extended Metal 9" Under Shelf Bracket for Tiered Shelves
PS-USB7+(Color)



Metal Under Shelf Bracket for Standard Shelves
PS-USB5RA+(Color)



Low Profile Metal Under Shelf Bracket for Tiered Shelves
PS-USB7-LPA+(Color)



Wire Over Shelf Bracket for Standard Shelves
PS-2OSB+(Color)

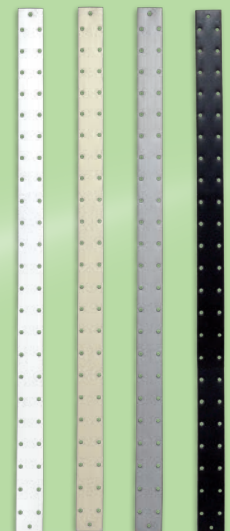

Color Code **I** **W** **G** **B**

SwingStrips®
1.25" Stock Hole Spacing

20" Length **PS-20A+(Color)**
30" Length **PS-30A+(Color)**
36" Length **PS-36A+(Color)**
White W Ivory I Grey Gr Black Bk

For peg hooks & accessories see pages 56-57



Increase Impulse Sales By In-Line and Cross-Merchandising

- Off shelf SwingStrips® make products stand out.
- Proven to out-sell traditional disposable plastic strips and J-hooks.
- SwingStrips® are made of extruded plastic in standard lengths of 20, 30 and 60 inches.
- Available in stock ivory or special order white, black or gray. Custom colors also available.
- Peg hooks are available in a variety of styles and lengths of 1-6 inches with or without UPC scan plates.
- Peg hook prongs snap and hide inside the extruded plastic for an extra clean presentation.
- Peg hook holes are drilled vertically every 1.25" or can be custom-spaced to accommodate your products.
- Add custom die-cut signs to further increase the visibility of merchandise or "brand" the display.



Wall SwingStrips®



BEST SELLER

CUSTOM COLORS

Fixed PowerBar™
 12" – PS-12F+(Back Plate #)
 16" – PS-16F+(Back Plate #)
 19" – PS-19F+(Back Plate #)

12" to 22"
Adjustable PowerArm®
 PS-1222+(Back Plate #)

PowerStrips™
 1.25" Stock Hole Spacing
 15" Length **PS-15A+(Color)**
 20" Length **PS-20A+(Color)**
 30" Length **PS-30A+(Color)**

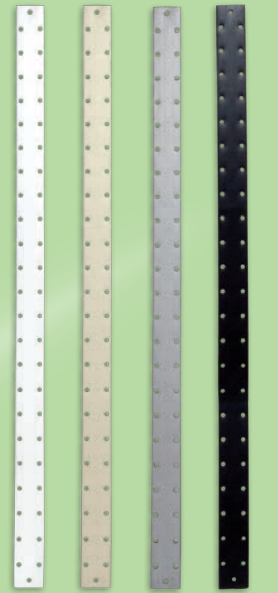

White **W** Ivory **I** Grey **Gr** Black **Bk**

16" to 26"
Adjustable PowerArm®
 PS-1626+(Back Plate #)

Offset Fixed PowerBar™
 12" – PS-12F1DSU1
 16" – PS-16F1DSU1
 19" – PS-19F1DSU1

22" to 32"
Adjustable PowerArm®
 PS-2232+(Back Plate #)

Add Back Plate Code to Part Number

Pegboard and 3" Slat Wall
PB

Single Slotted Upright
SS1

Single & Double Slotted Upright
DSU1

Universal 1-2 Slotted Uprights
DSU2

Pegboard Adapter for DSU PowerArms
PS-NPBBP-IV

For peg hooks & accessories see pages 56-57

Our gondola displays are environmentally friendly unlike disposable plastic merchandising strips.



Patented

Gain More Promotional Selling Space

- Patented fixed or adjustable PowerArms easily fasten onto pegboard, slat wall or slotted uprights.
- SwingStrips® are made of extruded plastic in standard lengths of 20 and 30 inches. Custom lengths available.
- Available in standard ivory or special order white, black or gray. Custom colors also available.
- Peg hooks are available in a variety of styles and lengths of 1-6 inches with or without UPC scan plates.
- Peg hook prongs hide inside the extruded plastic for an extra clean presentation and back-to-back merchandising.
- Peg hook holes are drilled vertically every 1.25" or can be custom-spaced to accommodate your products.
- Add custom die-cut signs to further increase the visibility of merchandise or "brand" the display.



Specialty SwingStrips®



SideWinder™
for Lozier & Madix Uprights
SW-4LRSS



SideWinder™
for Narrow Slot Uprights
SW-4LRDSU



Pallet Rack Bracket
PR-1



SideWinder™

- Easily fastens into uprights slots on end-caps and 4-way shoppers.
- Create a clean organized retail presentation.
- Order SideWinders in stock ivory color or opt for custom colors.
- Peg hooks are available in a variety of styles and lengths of 1-6 inches with or without UPC scan plates.
- Merchandise multiple products/price points per strip.

Pallet Rack Bracket

- Use on Pallet, Hypermax and Multi-Function Racks.
- Holds 2 to 3 times more than a merchandising strip.
- Greater visual impact than merchandising strips.
- Create a clean organized retail presentation.
- Merchandise multiple products/price points per strip.



PocketStrip



Custom Made to Order Pockets

- Designed to be used with our SwingStrips® and AMMO™ Strips.
- Cross merchandise for high velocity, high margin sales off shelves, walls, wing racks and pallet racks.
- Custom clear plastic pockets are designed to accommodate your products.
- PocketStrips are easily reloaded.



Data Strip
with Adhesive
2.0" - **DATASTRIP2.0FT**
2.5" - **DATASTRIP2.5FT**
3.0" - **DATASTRIP3.0FT**

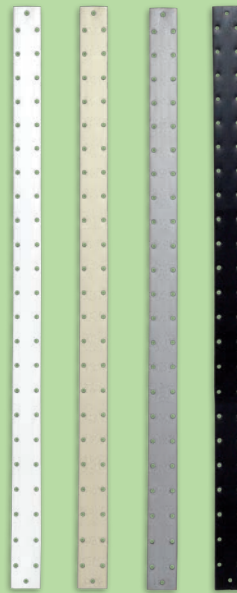

White W Ivory I Grey Gr Black Bk

PowerStrips™
1.25" Stock Hole Spacing
15" Length **PS-15A+(Color)**
20" Length **PS-20A+(Color)**
30" Length **PS-30A+(Color)**

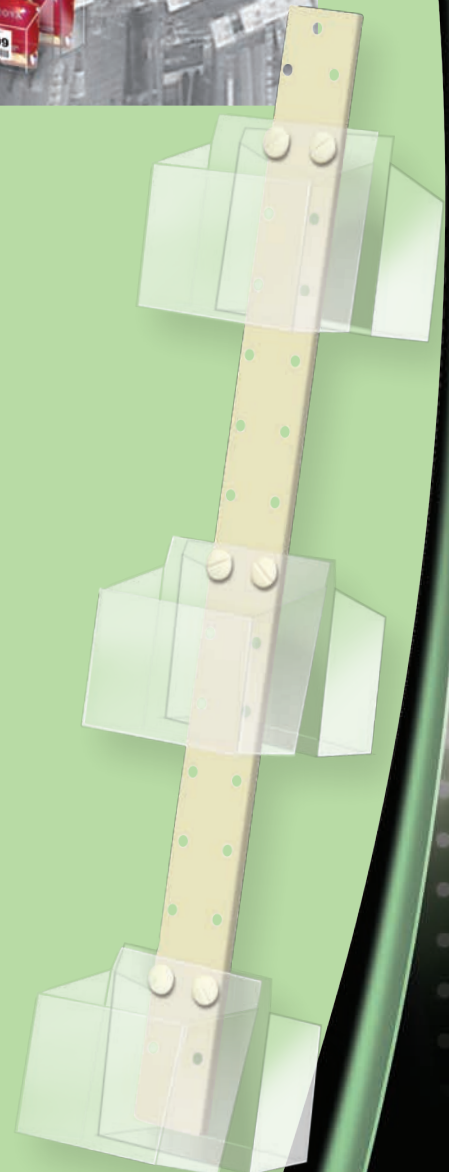

PowerStrips®



- Peg hooks are available in a variety of styles and lengths of 1-6 inches with or without UPC scan plates.

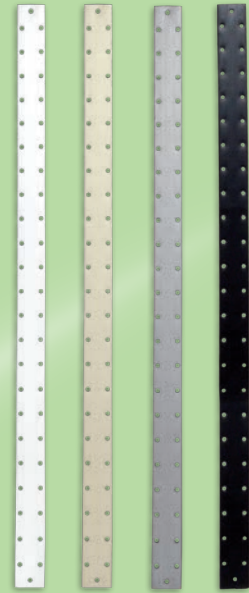
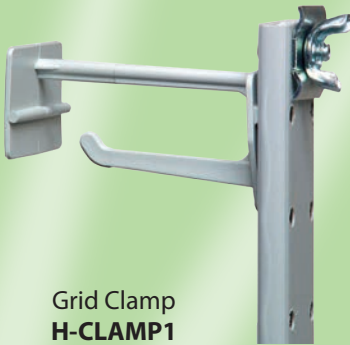

White W **Ivory I** **Grey Gr** **Black Bk**

PowerStrips™
1.25" Stock Hole Spacing

- 15" Length **PS-15A+(Color)**
- 20" Length **PS-20A+(Color)**
- 30" Length **PS-30A+(Color)**



End Cap Side Rail



Side of Wire Wing Rack



Merchandise Your Products Storewide

- Grid clamps Mount PowerStrip® to uprights, shelves, wire wing racks, and check out poles.
- PowerStrips® are made of extruded plastic in stock length of 20", 30", 36", 48" and 60". Custom lengths are also available.
- Creates great impact on impulse merchandising sales.
- Can be used virtually anywhere in the store for inline or secondary promotional cross-merchandising.
- Displays can be pre-packed in kit form, preassembled or CPG product pack-out.



Channel Magnets



S-Hook



Grid Clamp

MagnaStrip™

End Cap Side Rail



Pallet Rack



Check Out Pole



Place On Any Vertical Metal Surface

- MagnaStrips™ can be used on end cap side rails, refrigerators, coolers, poles or any other metal surface.
- Peg hook prongs hide inside the extruded plastic strip for an extra clean presentation.
- Add eye catching custom die cut signs.
- Displays can be pre-packed with product and we offer DTS drop shipping.

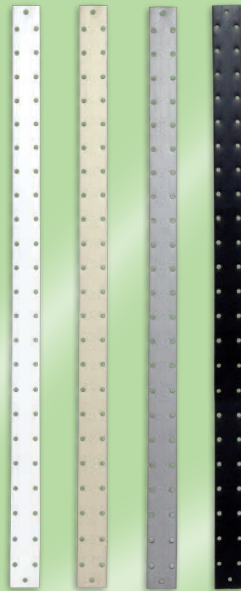

White W Ivory I Grey Gr Black Bk

PowerStrips™

1.25" Stock Hole Spacing

15" Length PS-15A+(Color)

20" Length PS-20A+(Color)

30" Length PS-30A+(Color)

Metal Post



CUSTOM COLORS



PromoStrips



Merchandise Your Products Storewide

- PromoStrips can be mounted with removable foam adhesive, channel magnets, small metal s-hook or flat plastic s-hook.
- These displays can be used virtually anywhere in the store for secondary, inline or promotional cross-merchandising.
- PromoStrip dimensions and graphics can be customized.
- Displays can be pre-packed with product and we offer drop shipping.
- Peg hooks are available in a variety of styles and lengths of 1-6 inches with or without UPC scan plates.



Plastic Tie Band
PS-TB11S



Metal S-Hook
PS-SHMS



Plastic Flat S-Hook
PS-PHP



Removable
Adhesive Strips
or Channel Magnets

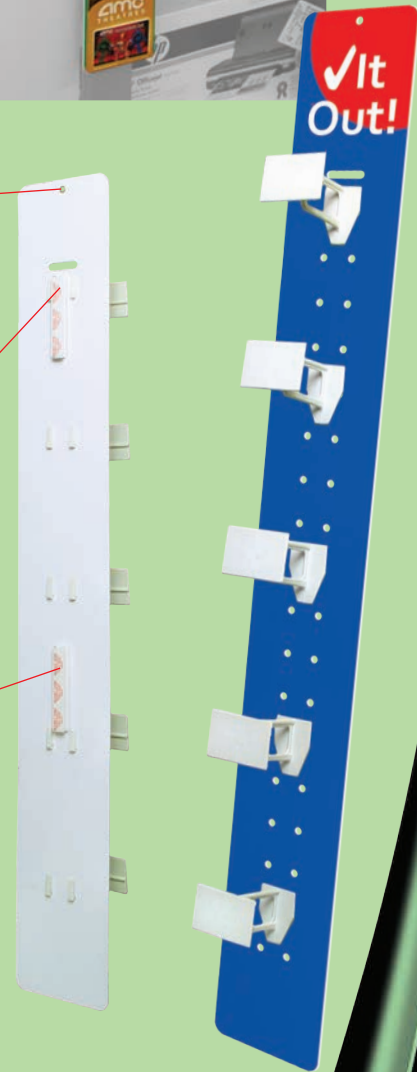

Greeting Card ArcArms™



Spark Impulse Sales In Your Greeting Card Category

- Metal paddle clip slides onto plastic greeting card dividers.
- Can be used with SwingStrips® or PromoPanel™.
- Ideal for gift cards or lightweight items.

8" Bent Back ArcArm™ for steep angled card sections
PS-LOOPGREET1C

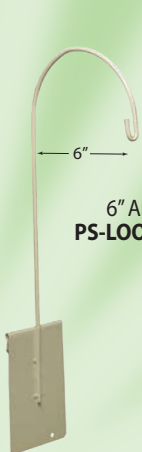

6" ArcArm™
PS-LOOPGREET-K



8" ArcArm™
PS-LOOPGREET1

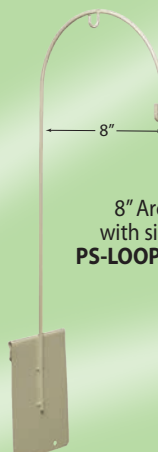

8" ArcArm™ with sign hook
PS-LOOPGREET-AX

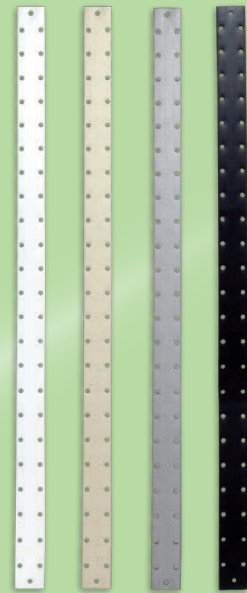

White W Ivory I Grey Gr Black Bk

PowerStrips™

1.25" Stock Hole Spacing

- 15" Length **PS-15A+(Color)**
- 20" Length **PS-20A+(Color)**
- 30" Length **PS-30A+(Color)**



Tri-Spinner PromoPanels™

OFF THE GONDOLA
Greeting Card ArcArm™ / Tri-Spinners



Custom Made to Order

- Tri-Spinner PromoPanels™ extend off of POG's uprights.
- Custom printed panels display your P.O.P. logo and graphics
- Peg hooks are available in a variety of styles and lengths of 1-6 inches with or without UPC scan plates.

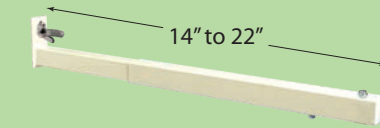

Adjustable PowerArm®
PS-1222-T-(Back Plate)-(Color)

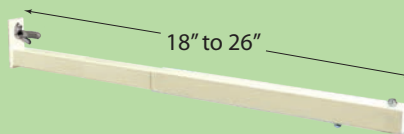

Adjustable PowerArm®
PS-1626-T-(Back Plate)-(Color)



Color Code **I** **W** **G** **B**

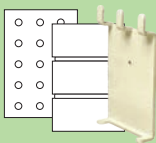

Pegboard and 3" Slat Wall
PB

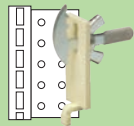

Single Slotted Upright
SS1

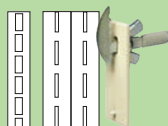

Single & Double Slotted Upright
DSU1

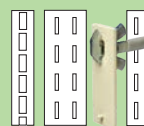

Universal 1-2 Slotted Uprights
DSU2



Pegboard Adapter for DSU PowerArms
PS-NPBBP-IV

800.992.5233 • email: hq@tmshea.com

AMMOStrip®

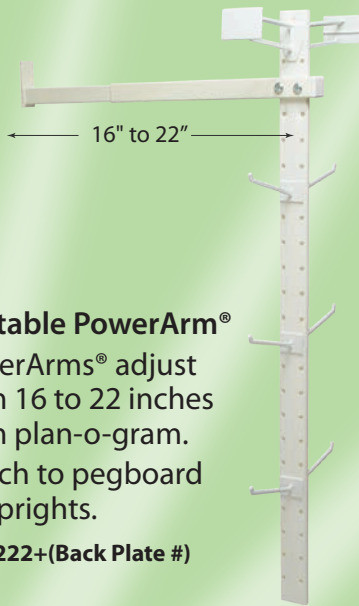
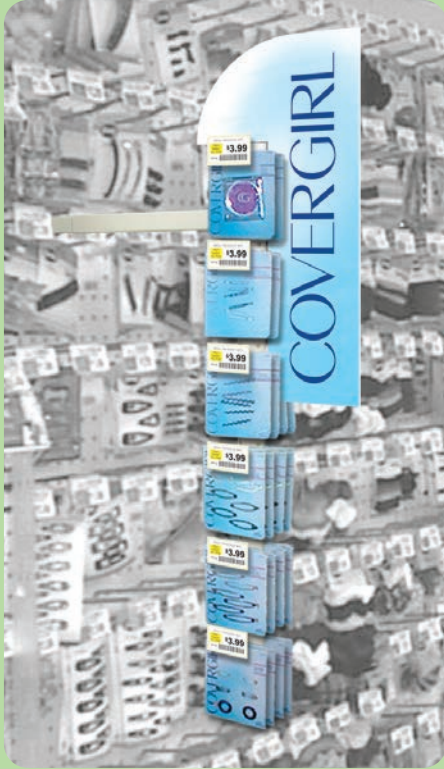

Adjustable PowerArm®

- PowerArms® adjust from 16 to 22 inches from plan-o-gram.
- Attach to pegboard or uprights.

AS-301222+(Back Plate #)



UnderShelf Bracket

- Extends non-swinging strips from metal shelving.

AS-30USB



Pallet Rack Bracket

- Securely attaches to pallet rack uprights.

AS-30PR1



Add Back Plate Code to Part Number

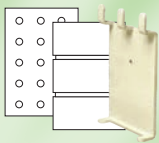

Pegboard and 3" Slat Wall
PB

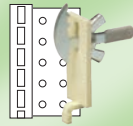

Single Slotted Upright
SS1

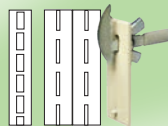

Single & Double Slotted Upright
DSU1

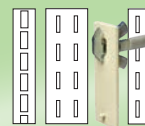

Universal 1-2 Slotted Uprights
DSU2



Pegboard Adapter for DSU PowerArms
PS-NPBBP-IV





Create Excitement in Every Aisle

- A variety of mounting options available.
- AMMOStrips™ are made of extruded plastic in stock length of 20" and 30". Custom lengths are also available.
- AMMOStrips™ available in standard ivory or special order white, black or gray. Custom colors also available.
- Peg hooks are available in a variety of styles and lengths of 1"-6" with or without UPC scan plates.
- Peg hook prongs hide inside the extruded plastic for an extra clean presentation and back-to-back merchandising.
- Peg hook holes are drilled vertically every 1.25" or can be custom-spaced to accommodate your products.
- Add custom die-cut signs to further increase the visibility of merchandise or brand the display.

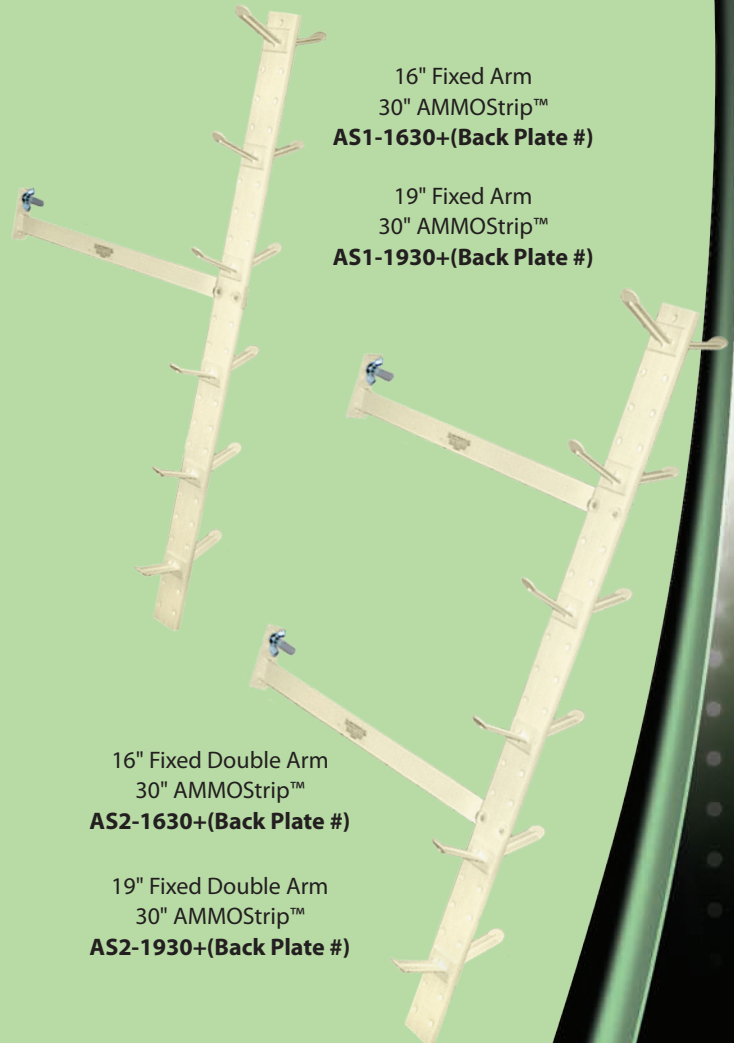

16" Fixed Arm
30" AMMOStrip™
AS1-1630+(Back Plate #)

19" Fixed Arm
30" AMMOStrip™
AS1-1930+(Back Plate #)

16" Fixed Double Arm
30" AMMOStrip™
AS2-1630+(Back Plate #)

19" Fixed Double Arm
30" AMMOStrip™
AS2-1930+(Back Plate #)

PermaPanels®

Adjustable PowerArm® Swing PermaPanel®



Double PowerArm® PermaPanel®

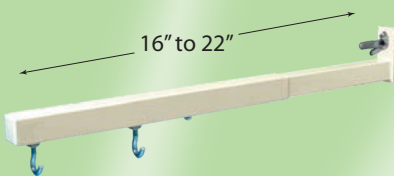

Adjustable PowerArm®
PS-1222D+(Back Plate #)



Fixed PowerBar™
16" – PS-16FD+(Back Plate #)
19" – PS-19FD+(Back Plate #)



PermaPanels®
5.5" Wide
1.25" Stock Hole Spacing
30" Length SSP-30
36" Length SSP-36
48" Length SSP-48

PermaPanel®
mounts in slot
with 2 bolts

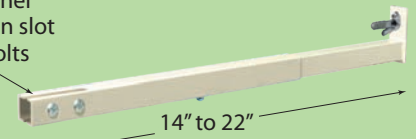

Adjustable AMMOArm®
AS-1422AMMO+(Back Plate #)+(Color)



Fixed PowerBar™
12" – PS-12F+(Back Plate #)
14" – PS-14F+(Back Plate #)
16" – PS-16F+(Back Plate #)
19" – PS-19F+(Back Plate #)

Add Back Plate Code to Part Number

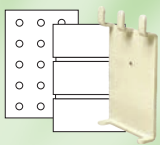

Pegboard
and 3" Slat Wall
PB

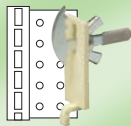

Single Slotted
Upright
SS1

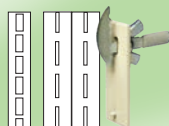

Single & Double
Slotted Upright
DSU1

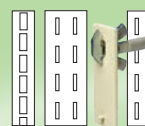

Universal
1-2 Slotted Uprights
DSU2



Pegboard Adapter
for DSU PowerArms
PS-NPBBP-IV

For peg hooks & accessories see pages 56-57



Our gondola displays are environmentally friendly unlike disposable plastic merchandising strips.

Adjustable AMMOArm® PermaPanel®



Maximize Impulse Sales

- Plastic PermaPanels® are 5.5" wide and available in a variety of lengths.
- PermaPanels® and Swing PermaPanels® easily fasten to pegboard, uprights or slat wall with our patented adjustable PowerArms® or fixed PowerBars™.
- The gentle sway of Swing PermaPanels®, caused by customer traffic, draws attention to the display.
- Complete the display by choosing from a variety of peg hooks and sign options.
- Merchandise multiple products/price points per panel.
- Add custom die-cut signs to further increase the visibility of merchandise brand awareness.

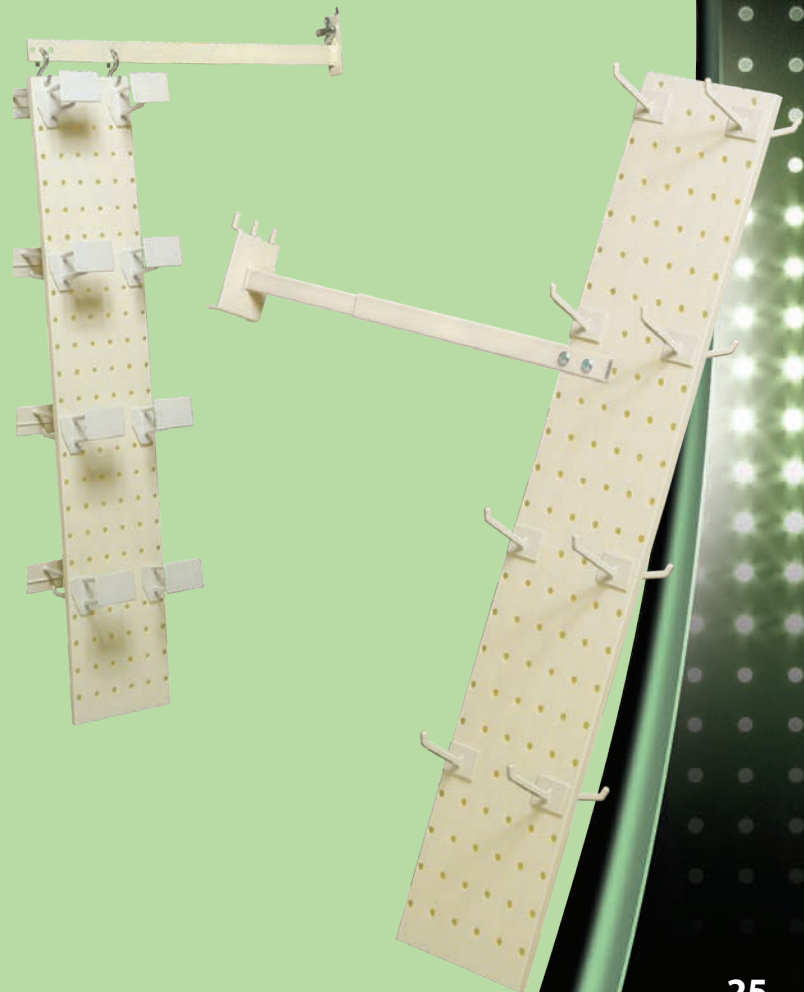

PromoPanels™



FlexGrip
Under Shelf Bracket
PP-USBFLEX



FlexGrip
Off Shelf Bracket
PP-OSBFLEX

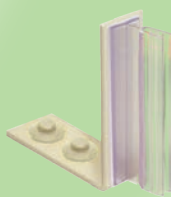

Over Shelf
Bracket
PP-OSPERMFLEX



Adjustable PowerArm®
PS-1222D+(Back Plate #)



Fixed PowerBar™
16" – **PS-16FD+(Back Plate #)**
19" – **PS-19FD+(Back Plate #)**

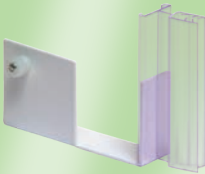

One-Bolt
Shelf Break Bracket
PS-USBB-FLX3-W

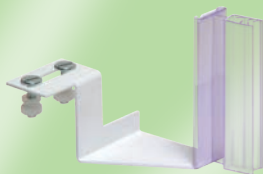

Off-Set Under Shelf
Break Bracket
PP-BB-USB6-W



FlexGrip
Pallet Rack Bracket
PP-PRFLEX



Metal Under Shelf Bracket
Low Profile
PS-USB7-LPA-H



Pallet Rack Bracket
PR-1NS



Fixed PowerBar™
16" – **PS-16F+(Back Plate #)**
19" – **PS-19F+(Back Plate #)**

Add Back Plate Code to Part Number

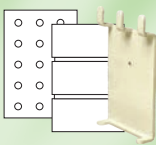

Pegboard
and 3" Slat Wall
PB

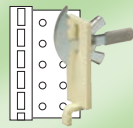

Single Slotted
Upright
SS1

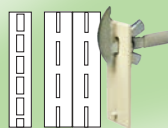

Single & Double
Slotted Upright
DSU1

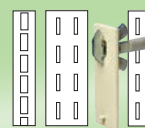

Universal
1-2 Slotted Uprights
DSU2



Pegboard Adapter
for DSU PowerArms
PS-NPBBP-IV





Heighten Brand Awareness

- Custom die-cut panels are designed to display graphics along with your merchandise.
- PromoPanels™ are made of durable styrene or laminated cardstock.
- Choose from a variety of peg hooks to accommodate your products.
- PromoPanels™ can be applied to a variety of arms and brackets.
- FlexGrip brackets give way to sideways pressure.
- High density display reduces in-store restocking.
- Merchandise multiple products/price points per panel.
- Custom made Trangle PromoPanel™ mounts to Pallet, Hypermax, or Multi-Function Racking (For mounting hardware see page 34)



Swing PromoPanel™

Custom PromoPanel™

Triangle PromoPanel™

800.992.5233 • email: hq@tmshea.com

Panel Grip Brackets & Arms

Mounting Arms

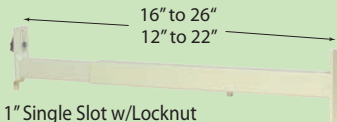

Adj. 1" Single Slot w/Locknut
PP-1626SS-FFST+(color)
PP-1222SS-FFST+(color)

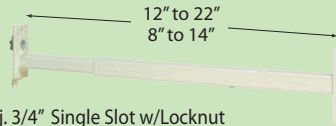

Adj. 3/4" Single Slot w/Locknut
PP-1222SS-34FFST+(color)
PP-814SS-34FFST+(color)



Adj. 1" Single Slot w/DSU hdwe.
PP-1626DSU-FFST+(color)
PP-1222DSU-FFST+(color)



Adj. 3/4" Single Slot w/DSU hdwe.
PP-1222DSU-34FFST+(color)
PP-814DSU-34FFST+(color)



Adj. 1" Pegboard
PP-1626PB-FFST+(color)
PP-1222PB-FFST+(color)



Adj. 3/4" Pegboard
PP-1222PB-34FFST+(color)
PP-814PB-34FFST+(color)

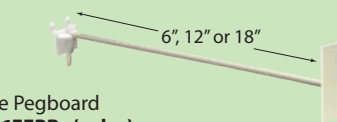

Wire Pegboard
PP-6FFPB+(color)
PP-12FFPB+(color)
PP-18FFPB+(color)

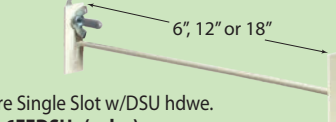

Wire Single Slot w/DSU hdwe.
PP-6FFDSU+(color)
PP-12FFDSU+(color)
PP-18FFDSU+(color)

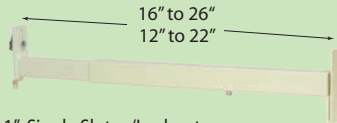

Adj. 1" Single Slot w/Locknut
PP-1626SS-FFSL+(color)
PP-1222SS-FFSL+(color)

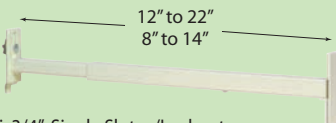

Adj. 3/4" Single Slot w/Locknut
PP-1222SS-34FFSL+(color)
PP-814SS-34FFSL+(color)

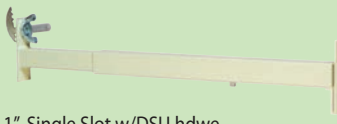

Adj. 1" Single Slot w/DSU hdwe.
PP-1626DSU-FFSL+(color)
PP-1222DSU-FFSL+(color)



Adj. 3/4" Single Slot w/DSU hdwe.
PP-1222DSU-34FFSL+(color)
PP-814DSU-34FFSL+(color)



Adj. 1" Pegboard
PP-1626PB-FFSL+(color)
PP-1222PB-FFSL+(color)

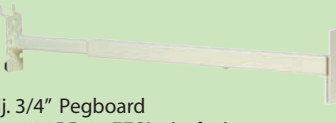

Adj. 3/4" Pegboard
PP-1222PB-34FFSL+(color)
PP-814PB-34FFSL+(color)

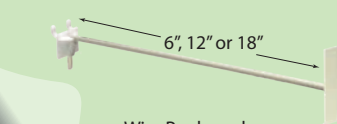

Wire Pegboard
PP-6FFPB+(color)
PP-12FFPB+(color)
PP-18FFPB+(color)

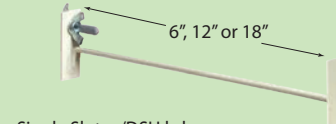

Wire Single Slot w/DSU hdwe.
PP-6FFDSU+(color)
PP-12FFDSU+(color)
PP-18FFDSU+(color)



Stick On a Grip

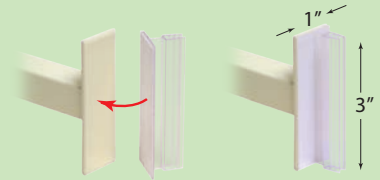

Stick On Non-Flexible Panel Grips

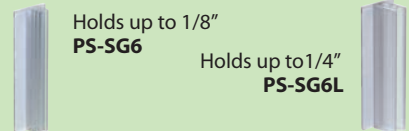

Stick On Flexible Panel Grips

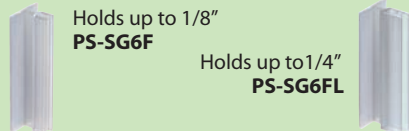

Under Shelf Bracket



Over Shelf Bracket

PP-OSPERMFLEX

Slip on Panel Grips

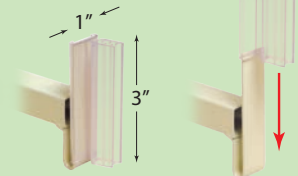

Slip On Non-Flexible Panel Grips

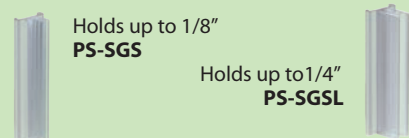

Slip On Flexible Panel Grips



Shelf Brackets

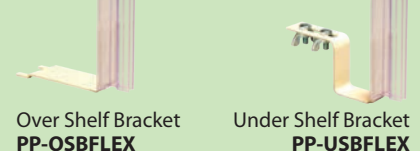

Heavy Duty Promo Panels

OFF THE GONDOLA
Heavy Duty Promo Panels

PowerArm PromoPanel™



Shelf Bracket PromoPanels™



Glass Bracket PromoPanels™



NEW



Great for New Product Launches

- Cross merchandise for high velocity, high margin sales in pegged, shelved and glass door areas.
- Custom die-cut panels are designed to display graphics along with your merchandise.
- PromoPanels™ made of durable styrene, laminated cardstock, and E-flute cardboard materials.
- PromoPanels™ can be designed for flat or folded panels

For peg hooks & accessories see pages 56-57

Custom Graphics and Hole Patterns



Panel Hooks attach nearly back-to-back in Heavy Duty PromoPanels

800.992.5233 • email: hq@tmshea.com

PSE Cards & Displays

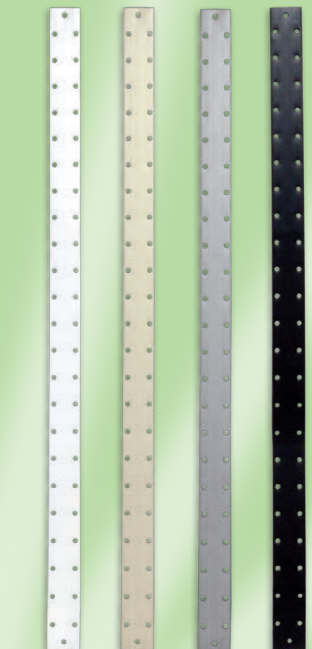

White W
Ivory I
Grey Gr
Black Bk

SwingStrips®
1.25" Stock Hole Spacing
20" Length PS-20A+(Color)
30" Length PS-30A+(Color)

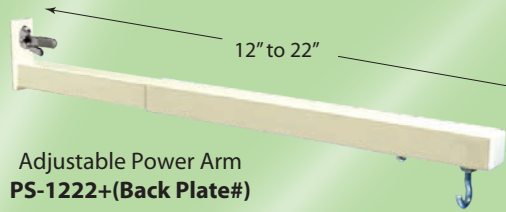

Adjustable Power Arm
PS-1222+(Back Plate#)

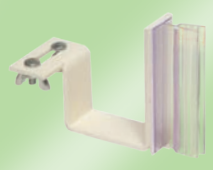

Space Management Under Shelf Bracket
PP-USB6FLEX

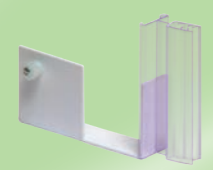

One-Bolt Shelf Break Bracket
PS-USBB-FLX3-W

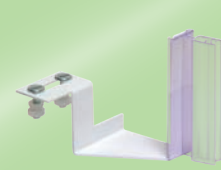

Off-Set Shelf Break Bracket
PP-BB-USB6-W



Metal Low Profile Under Shelf Bracket
PS-USB6V1-LPA



Metal Under Shelf Bracket
PS-USB6V1





Why PSE Card Displays?



Sales have fallen off dramatically of pseudoephedrine products for cough, cold, and allergy, since the removal of PSE products from the POG. This system provides a way to display cards in front of the customer without disrupting the current OTC product mix and taking away valuable shelf space. This display meets your shoppers needs and will accelerate your PSE sales.

- PSE Card Flex Pocket Panels offer you and your shoppers a sleek low profile and visually exciting promotional display system.
- Each panel displays 12 PSE cards to inform the customer of your PSE product offers.
- We also print and provide the Pocket Panel PSE cards offering you a complete turn-key kit.
- PSE Pocket Panel Cards offer the customer the ability to:
 - Compare product labels and Pricing
 - Find information on duration



PSE Pocket Panel Cards

CBD PocketPanels™

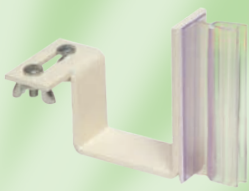
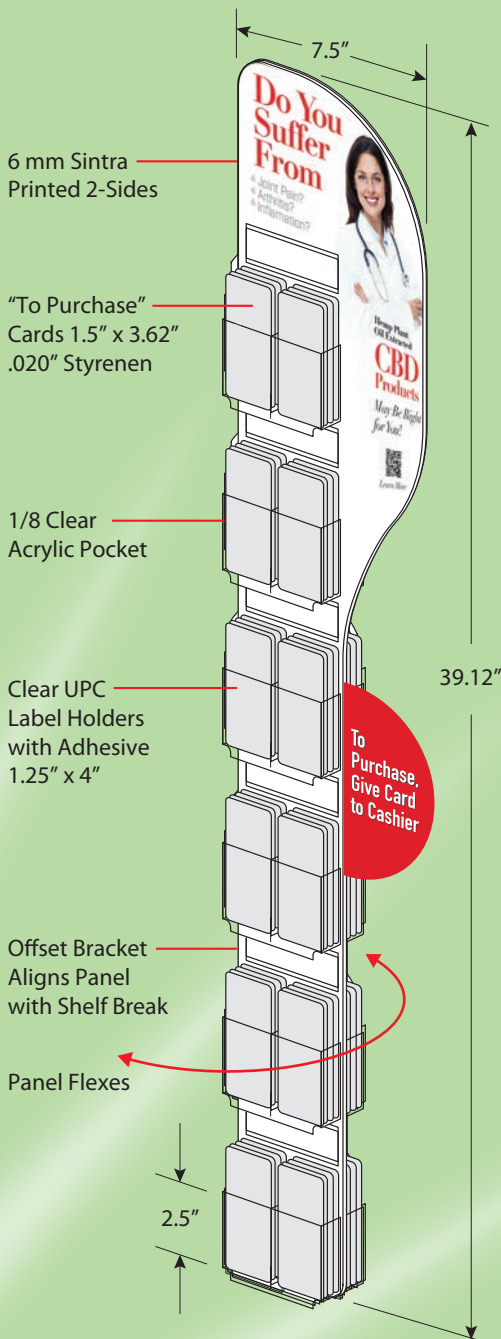

Shelf Management Under Shelf Bracket
PP-USB6FLEX

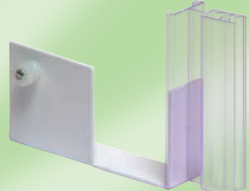

One-Bolt Shelf Break Bracket
PS-USBB-FLX3-W



Off-Set Shelf Break Bracket
PP-BB-USB6-W

"To Purchase" cards offer multiple benefits. They provide security, dramatically reduce the amount of shelf space required, and act as an inventory tracking system.



Our gondola displays are environmentally friendly unlike disposable plastic merchandising strips.



Why Flex Pocket Panel Displays

The fundamental questions surrounding this high-growth business are in-store location and inventory management. As you might agree, CBD products belong in OTC within the vitamin and supplement POG, and they should also be promoted within the pain relief and skin care departments. You may choose to have a dedicated front end cap for CBD Central and promote the product through the card system in relative areas like vitamins, pain relief and skin categories.

- **CBD Category Awareness and Multiple Product Benefits:** while awareness of the many CBD product benefits is increasing, it is not often a destination purchase and, therefore, should be promoted in the relevant departments (e.g., pain relief, skincare, and vitamins/supplements).
- **Product Placement:** POG placement occupies valuable shelf space, forces revisions, SKU rationalization, and creates sales risk for existing SKUs.
- **Loss of Productivity:** Store management is required to monitor security cases (locking/unlocking) throughout the day.
- **SKU Duplication:** Three in-line locations will drive significant incremental inventory dollar expense.



PowerTowers™

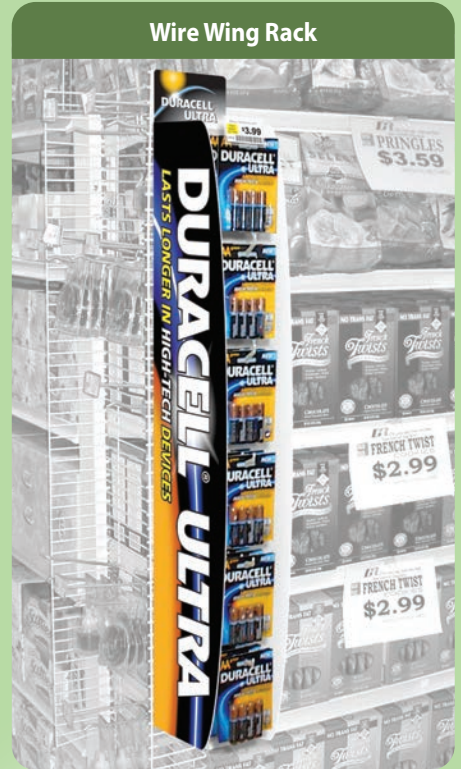
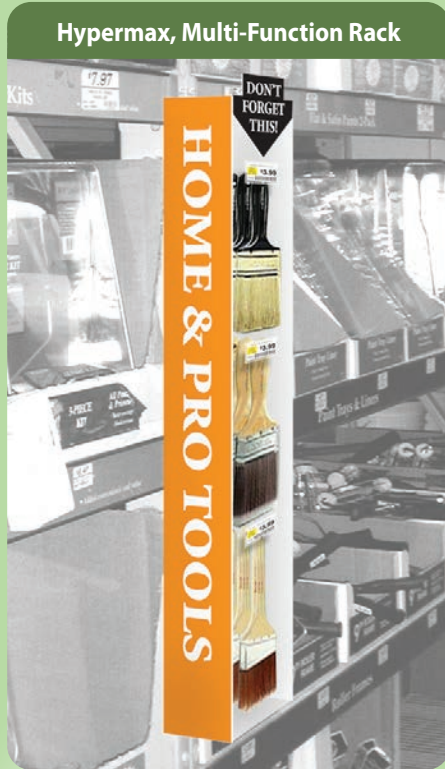
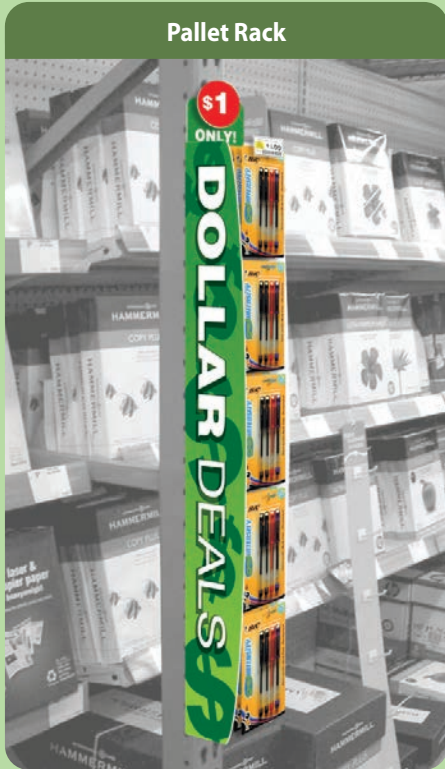

Secondary Displays Help Stimulate Additional Sales

- PowerTowers™ are custom ordered to display your merchandise off of pallet, hypermax, multi-function vertical racking and wire wing racks.
- Custom printed side panels and headers display your P.O.P. logo and graphics.
- Peg hooks are available in a variety of styles and lengths of 2 to 6 inches with or without UPC scan plates.



Teardrop Pallet Rack Plastic S-Hook
PS-PHP-PR

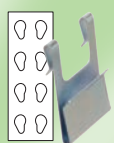

Teardrop Pallet Rack Metal S-Hook
PS-PHM-P



Hypermax Multi-function Flipper Nut
H-FLN-MFRK



Wing Rack Plastic Flat S-Hook
PS-PHP



Plastic Tie Band
PS-TB115



Our gondola displays are environmentally friendly unlike disposable plastic merchandising strips.



Custom
Made to
Order

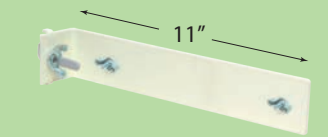

11" Front Mount
End Cap Bracket **PT-SW11SSF-I**

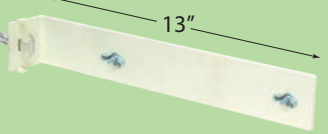

13" Rear Mount
End Cap Bracket **PT-SW11SSR-I**



16" Fixed PowerBar™
with fasteners **PS-16FDSU1-NS**

19" Fixed PowerBar™
with fasteners **PS-19FDSU1-NS**

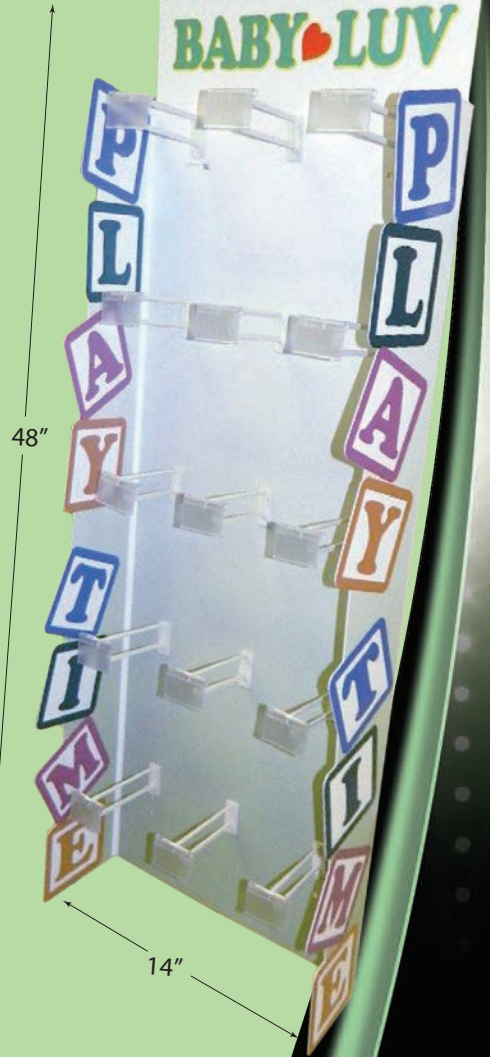

Wire PowerWings™

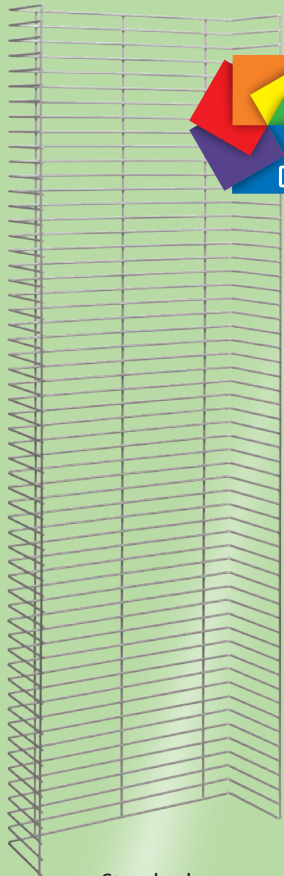

Standard PowerWing™
4.5"D x 14"W x 48"H
AG-PR-SIV(X)



PowerWing Sign Grip
PS-WSG



Mini PowerWing™
4.5"D x 14"W x 23"H
AG-PR23-SIV(X)



2" Metal Grid Hook
AGP-T2MCB



2" Metal Grid Hook with Flip Scan
AGPS-T2MCB

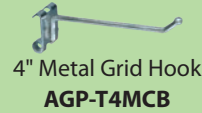

4" Metal Grid Hook
AGP-T4MCB



4" Metal Grid Hook with Flip Scan
AGPS-T4MCB

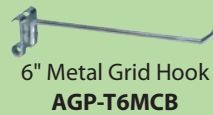

6" Metal Grid Hook
AGP-T6MCB



6" Metal Grid Hook with Flip Scan
AGPS-T6MCB



2" Black Metal Grid Hook with Flip Scan
AGPS-T2MCB-B



4" Black Metal Grid Hook with Flip Scan
AGPS-T4MCB-B



Crystal Clear Bucket
6.5"w x 6.5"d
B80



Grid Ring
TMS# GR



Bucket Ring Scan Tag
ST-3

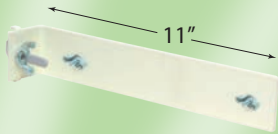

11" Front Mount End Cap Bracket
PT-SW11SSF-I

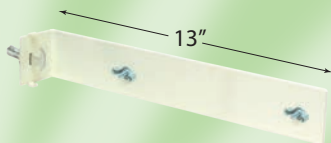

13" Rear Mount End Cap Bracket
PT-SW11SSR-I

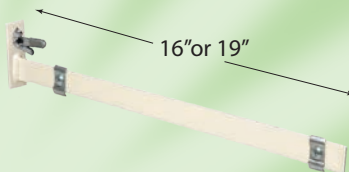

16" Fixed PowerBar™
PS-16FDSU1
19" Fixed PowerBar™
PS-19FDSU1

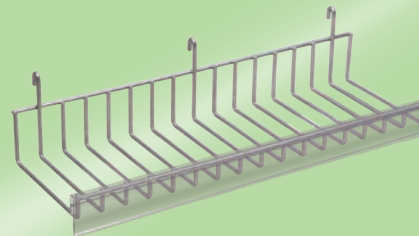

Wire Shelf
4.5"D x 13.75"W x 1"H
AG-SHLF4.5(Color)

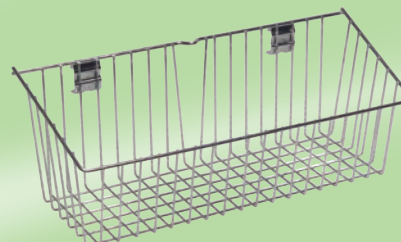

Wire Basket
5"D x 13.25"W x 3.25"H
AG-BASKET



Our gondola displays are environmentally friendly unlike disposable plastic merchandising strips.



Get Maximum Sales From End Cap Sides

- Attach PowerWings™ to end cap side rails.
- Use with a variety of metal grid hooks with or without scan plates.
- Fixed PowerBars™ and end cap brackets mount onto end cap uprights.
- All mounting arms come with appropriate hardware for installation.
- Custom grid sizes and colors are available.
- P.O.P. graphics on header and side panels can be changed out.



Pegboard Wings™



12" Front Mount
End Cap Bracket
PT-SW11SSF-I



12" Rear Mount
End Cap Bracket
PT-SW11SSR-I



4" & 6"
Plastic Peg Hook
MPWP-P4-B
MPWP-P6-B



4" & 6"
Metal Peg Hook
MPWP-4-B
MPWP-6-B



4" & 6" Plastic Peg Hook
with Flip Scan
MPWP-P4S-B
MPWP-P6S-B



4" & 6" Metal Peg Hook
with Flip Scan
MPWP-4S-B
MPWP-6S-B

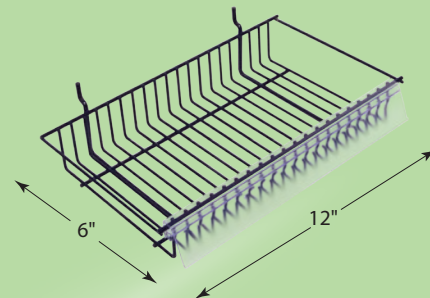

Wire Shelf
WS-0612BL-B



6.5" Peg Board Ring
TMS# BR6.5-B



Bucket Ring Scan Tag
ST-3



Peg Board
BucketRax
PWP-BR-80BLK



16" Fixed PowerBar™
PS-16FDSU1

19" Fixed PowerBar™
PS-19FDSU1



Crystal Clear Bucket
6.5"w x 3.5"d
B44



Crystal Clear Bucket
6.5"w x 6.5"d
B80



Get Maximum Sales From End Cap Sides

- Create an eye-catching end cap side display with Pegboard Wings™.
- Use with a variety of peg hooks with or without scan plates.
- Wire shelves, plastic dump bins and plastic buckets are available to accommodate your products.
- Extension arms attach to end cap side rails.
- All mounting arms come with appropriate hardware for installation.
- Custom sizes and colors are available.

For acrylic dump bins, see page 76-77

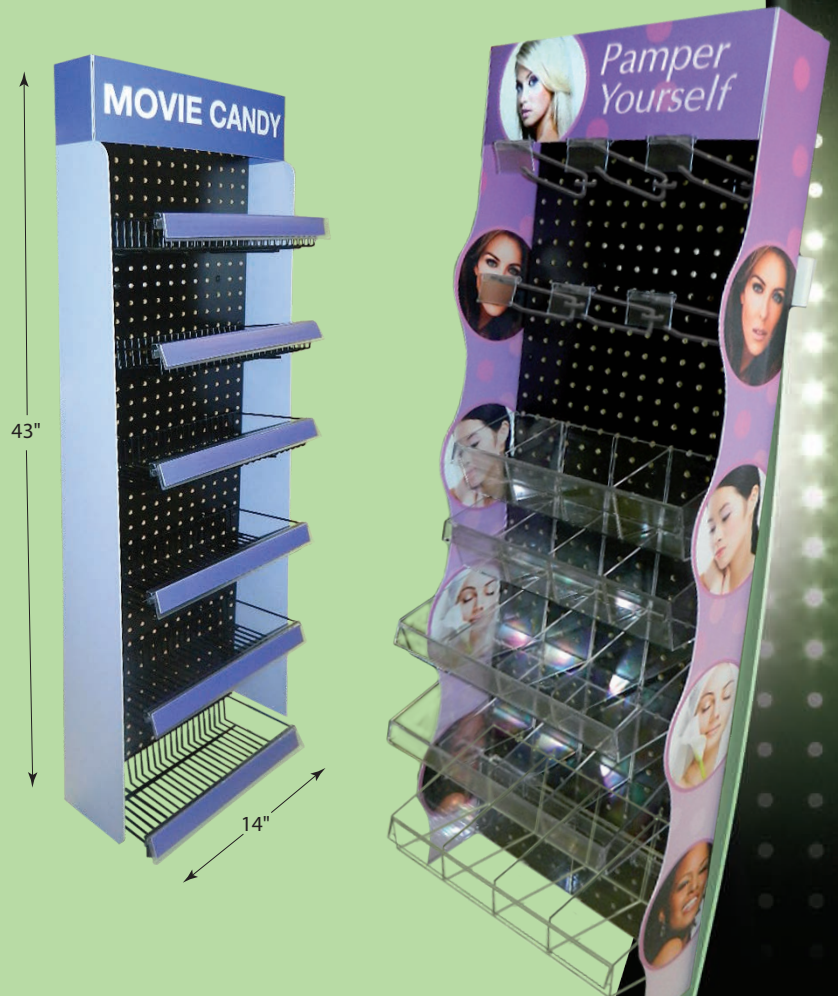

Basket & Bin Display



Reach Out and Touch Your Shoppers

- Universally mounts to most shelving
- Ideal for cross merchandise retail impulse products
- Great for up-selling customers and new product launches.
- Custom Sizes

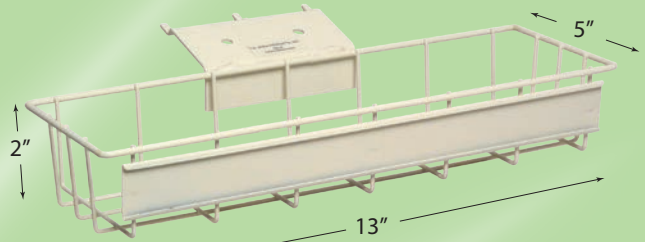

13" Wire Basket Shelf Extender
SEWB-0413

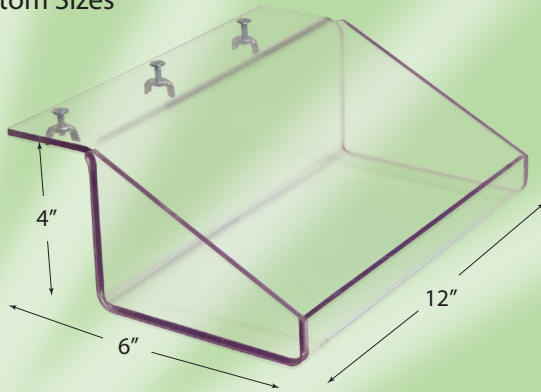

Clear Plastic Bin Shelf Extender
SEAB-0612

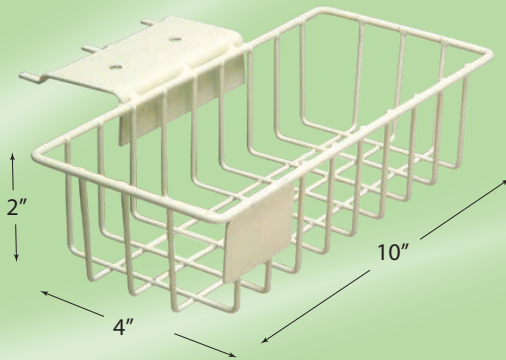

10" Wire Basket Shelf Extender
SEWB-0410



Our gondola displays are environmentally friendly unlike disposable plastic merchandising strips.

Security End Cap PowerWing

NEW

OFF THE GONDOLA
Bin Display / Lockable Security PowerWing



Patents Pending

Protect Your Products & Reduce Theft

- Offered in both 48" and 60" heights for CBD and other high security products for endcap sides
- 18" wide x 10" deep
- Metal shelving or peg hooks for UPC shelf labels
- The arms bolt down to the back of the display
- Custom sign packages available
- 2 Key/locks per door



Mounting Arm Lock
Very Secure & Strong

Available in 48" or 60"



18x48" End Cap PowerWing
WSC-EC48

18x60" End Cap PowerWing
WSC-EC60

800.992.5233 • email: hq@tmshea.com

Heat Up Cooler/Freezer Door Sales



Glass Bracket PowerStrip®

Glass Bracket
Power Strip®
PS-FDB1

Foam
Adhesive



Glass Bracket SwingStrip® Bracket

Glass Bracket SwingStrip®
White - PS-GB2-W
Black - PS-GB2-B



Glass Bracket Flex Panel

Glass Bracket PromoPanel
with Panel Flex Grip
White - PP-GB2-W
Black - PP-GB2-B



Cooler/Freezer Display

- Use on cooler/freezer glass doors
- Holds 2 to 3 times more than a merchandising strip.
- Merchandise multiple products/price points per strip.

1-Sided or 2-Sided

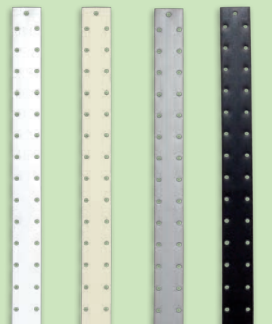

White W
Ivory -
Grey G
Black BK

SwingStrips®

1.25" Standard Hole Spacing
20" Length PS-20A+(Color)
30" Length PS-30A+(Color)



Patented

PromoPanel™

Custom holes
printed 1 or 2 sided

Custom
Shapes
& Sizes

PromoPanel™

1.25" Standard
Hole Spacing
printed 1 or 2 sided



CUSTOM COLORS

Cooler/Freezer Door Display



Custom 3 Shelf
Freezer Door Hanger
Black-**AFS-KFDWB-B**
White-**AFS-KFDWB-W**



5-Shelf
Freezer Door Hanger
PS-FD4SB-B



Small Deli Tray
4 Shelf Freezer Shelf Hanger
FSH-4X-0208 (Black)

2.5" Data Strips-Black
DATASTRIP2.5FT-B
or
2.0" Flip Up
Scan Plate
PSH-FLIPSCAN2

Custom
Stickers
3"W x 2"H

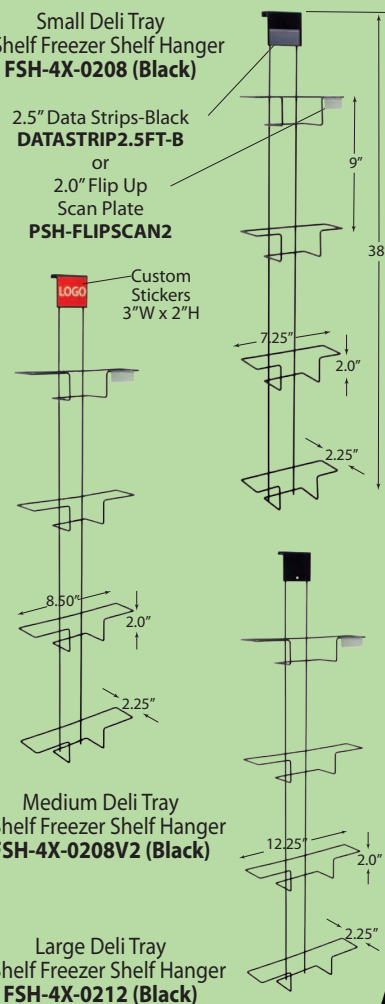

Medium Deli Tray
4 Shelf Freezer Shelf Hanger
FSH-4X-0208V2 (Black)

Large Deli Tray
4 Shelf Freezer Shelf Hanger
FSH-4X-0212 (Black)

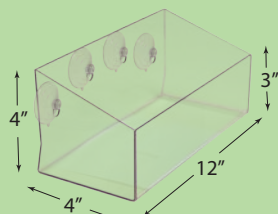

Outside
Plastic Suction Bin
SCB-1334

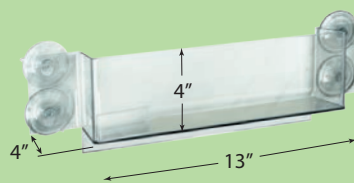

Inside/Outside
Plastic Suction Bin
SCB-IM-1344

SpeedStrip™



1.25" Clamp Mount
SpeedStrip™
PR-90X18SS-B



30° 1.5" Clamp Mount
SpeedStrip™
PR-30X18SS-B



Screw Mount
SpeedStrip™
PR-SMT14-B



Choose Your
Bracket, Strips,
Pegs & Signs

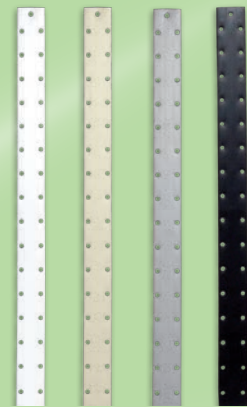

White W
Ivory I
Grey Gr
Black Bk

SpeedStrips®
1.25" Stock Hole Spacing
20" Length PS-20A+(Color)
24" Length PS-24A+(Color)





Cross Merchandise in Your Produce Department

- Quickly clamp SpeedStrips™ to tables and produce racks.
- SpeedStrips™ are supported by a metal insert and heavy duty clamp.
- SpeedStrip™ can be faced parallel or perpendicular to base.
- Table Top SpeedStrips™ use adhesive strips on base for stable mounting.

Adjustable
Micro Produce Rack
SpeedStrip™
PR-18-B

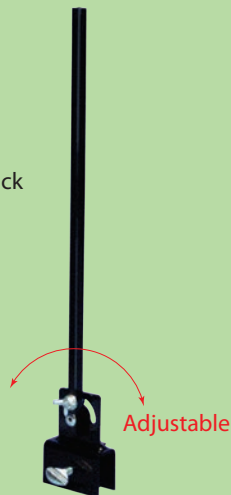

Table Top
SpeedStrip™
PS-BASE12-B



SpeedStrip™
Slides
Down



SpeedPegs



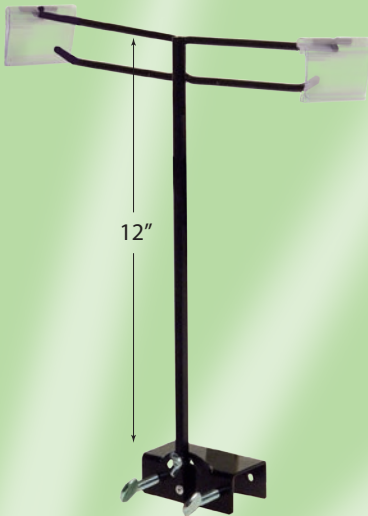

Patents Pending

CUSTOM COLORS

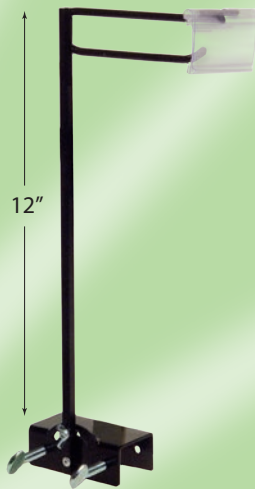

Double SpeedPeg
with Square Bar
Adjustable Clamp Mount



Single SpeedPeg
with Square Bar
Adjustable Clamp Mount



Double SpeedPeg
with Flat Bar
Adjustable Clamp Mount

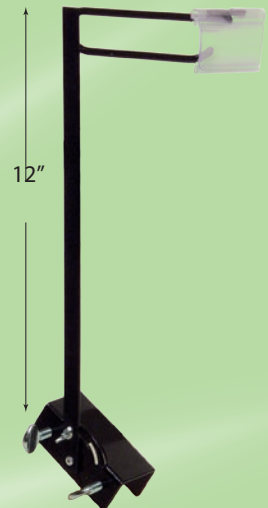

Single SpeedPeg
with Flat Bar
Adjustable Clamp Mount





Ideal for Produce, Meat, and Dairy Departments

- Great for cross merchandising impulse sales.
- Easily attaches to fixtures with clamps and angle adjusts from 0° to 45°.
- Vertically adjustable versions extend 12" to 18" from the base.

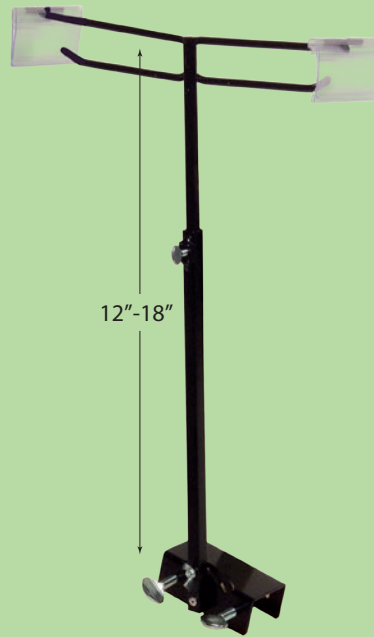
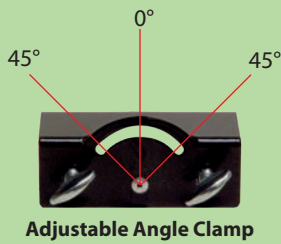

SpeedBars™

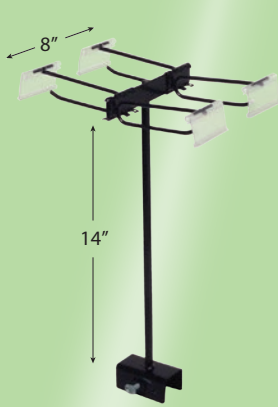

1.5" Clamp Mount
8" SpeedBar™
PR-TC1408S-B



30° 1.5" Clamp Mount
8" SpeedBar™
PR-ATC1408-B

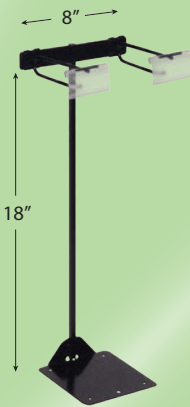
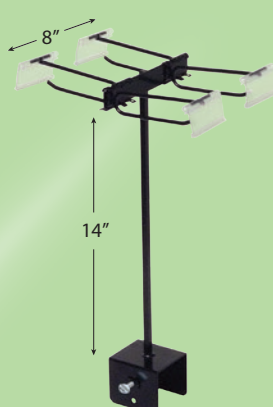

Table Top
8" SpeedBar™
PR-TT1808-B



2.5" Clamp Mount
8" SpeedBar™
PR-TC1408L-B



Table Top
14" SpeedBar™
PR-TT1814-B

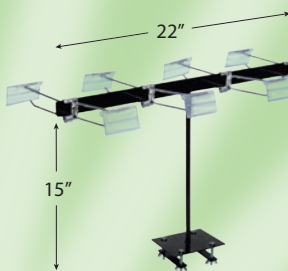

Apparel Rounder
Universal SpeedBar™
SB-PLATE22

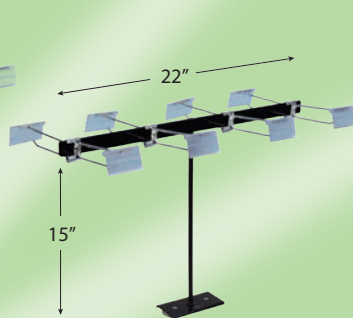

Magnetic Top Rail
SpeedBar™
SB-MAGNET22



Gondola Riser
SpeedBar™
GRS-WINERACK

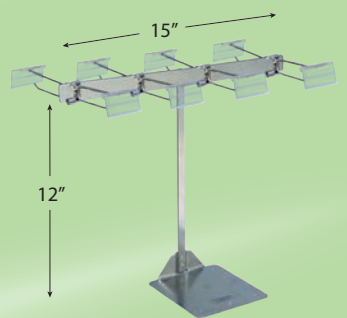

Table Top
SpeedBar™
PS-BASE12T-C



For peg hooks see page 36



Our gondola displays are environmentally friendly unlike disposable plastic merchandising strips.



Ideal for Produce, Meat, Dairy Departments

- Great for cross merchandising impulse sales.
- Easily attaches to fixtures with clamps or screws.
- Display a variety of products.
- Use with a variety of peg hooks with or without scan plates.



KneeKnocker Racks



Spark impulse sales in your open cooler sections

- Give your shoppers meal solutions for improved and tastier meals
- Generates more sales and profits for the stores
- Pulls center store products out into the perimeter for customer promotions with private label products and other new and seasonal products
- Delivers significant value for both shoppers and retailer.

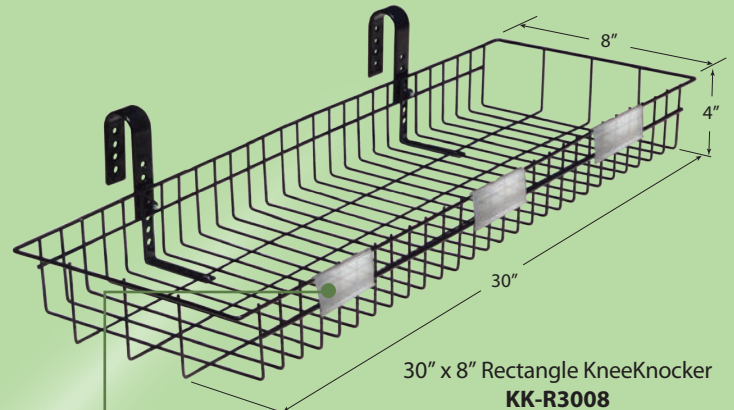

Tie-Band Mounting

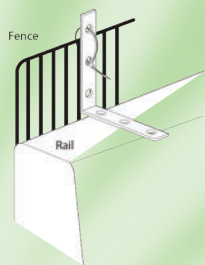

Vertical Adjustment Mounting Heights

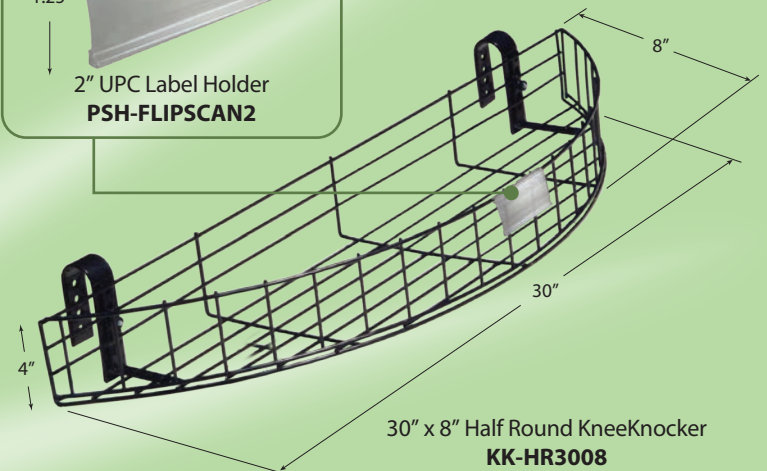
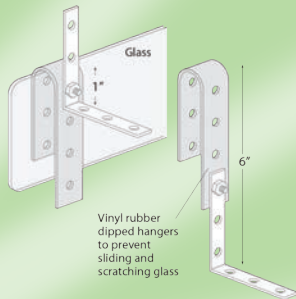

Our gondola displays are environmentally friendly unlike disposable plastic merchandising strips.

SkyBars. Elevate Your Sales.

OFF THE GONDOLA
Kneeknockers / SkyBars



Ideal for Open Cooler Placement:
Produce, Dairy, Meat and Beer



48" SkyBar
PS-SB48-B

3 Holes for Sheet Metal
Screws (Supplied)



36" SkyBar
PS-SB36-B

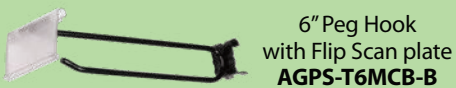

6" Peg Hook
with Flip Scan plate
AGPS-T6MCB-B



4" Peg Hook
with Flip Scan plate
AGPS-T4MCB-B



14" SkyBar
PS-SB14-B

2 Holes for Sheet Meta
Screws (Supplied)

800.992.5233 • email: hq@tmshea.com

Adjustable BunkerBridges

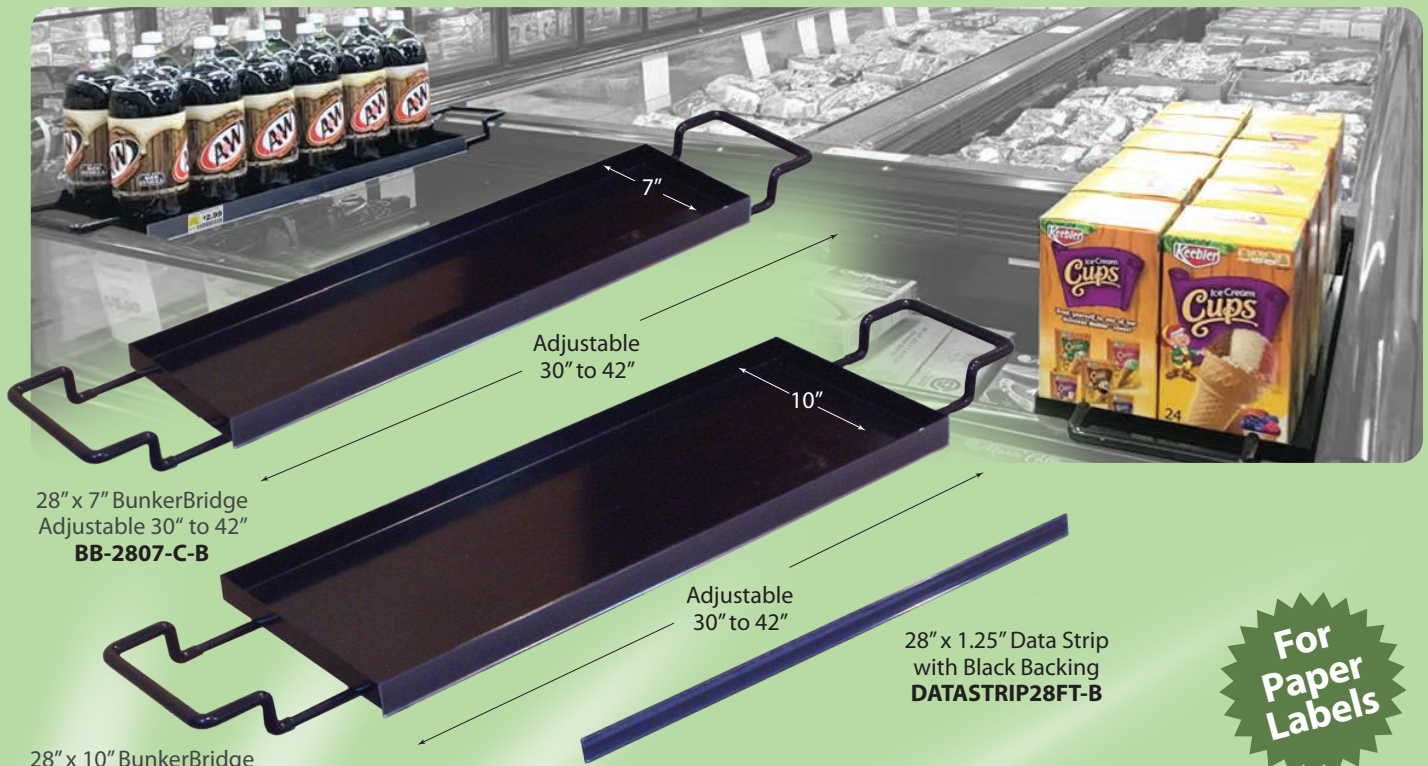

28" x 7" BunkerBridge
Adjustable 30" to 42"
BB-2807-C-B

28" x 10" BunkerBridge
Adjustable 30" to 42"
BB-2810-C-B

28" x 1.25" Data Strip
with Black Backing
DATASTRIP28FT-B



UPC Label & Sign Options



1" Plastic Parallel Sign Grip
PS-SG11



1" Plastic Perpendicular Sign Grip
PS-SG12



1" Non-Flexible Magna Grip
PS-SG1MAG



2.5" x 1.25" with 1" Adhesive
DATASTRIPMAG2FB





Adjustable 60" - 84" BunkerBridges™ are Ideal for Freezer Bunkers & Cooler Coffins

- Capture unused 'air space' for new sales
- Gain new customer solution by cross merchandising related products
- Be first to market with new products.
- Increase store sales and profits.
- Rubber coated handles for non-slip grip on rails



58" x 10" BunkerBridge
Adjustable 60" to 84"
(without Prong Hooks)
BB-5810-B

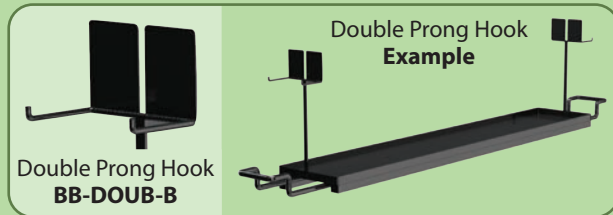
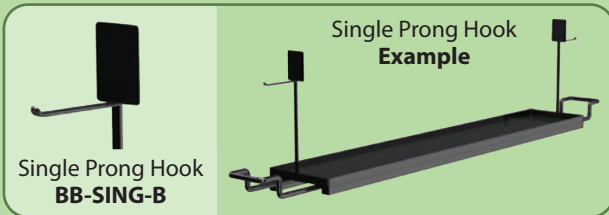

800.992.5233 • email: hq@tmshea.com

Lockable Plastic Security Cases

Standard Security Cases

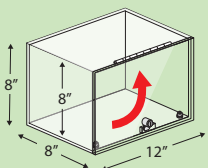

CSC-ST120808

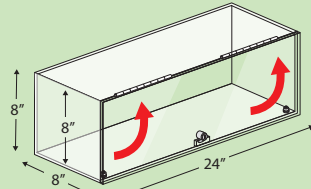

CSC-ST240808

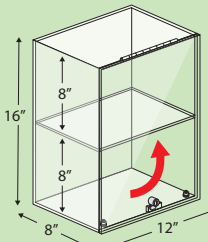

CSC-ST120816

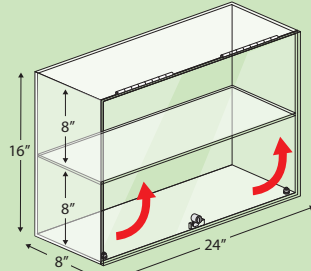

CSC-ST240816

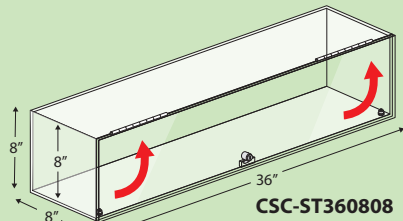

CSC-ST360808

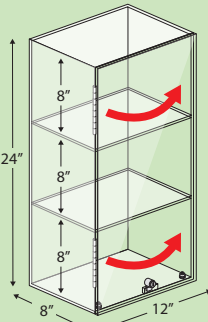

CSC-ST120824

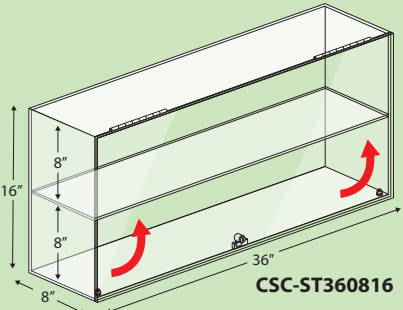

CSC-ST360816

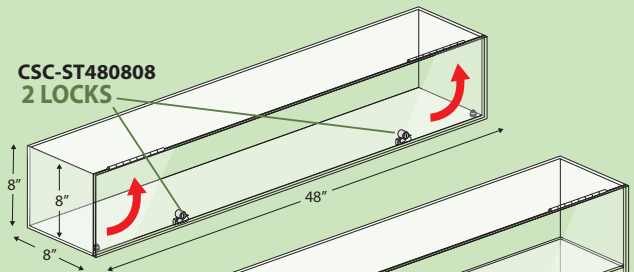

CSC-ST480808
2 LOCKS

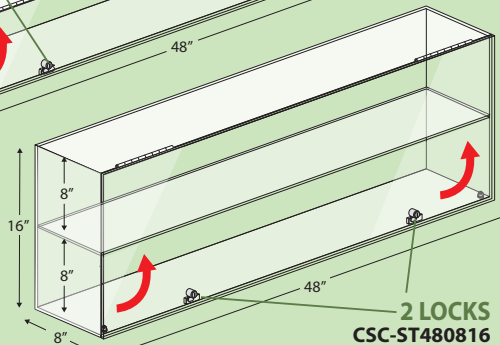

2 LOCKS
CSC-ST480816



Deluxe Security Cases with UPC Shelf Edge

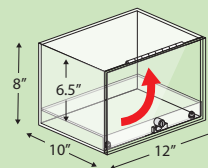

CSC-DL12108

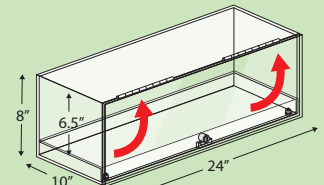

CSC-DL24108

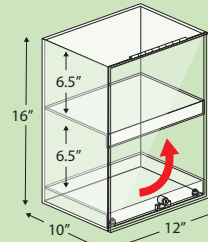

CSC-DL121016

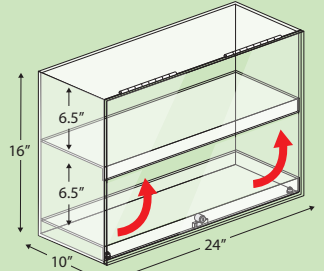

CSC-DL241016

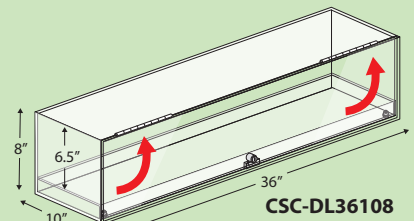

CSC-DL36108

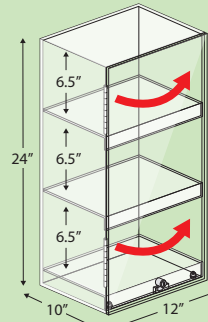

CSC-DL121024

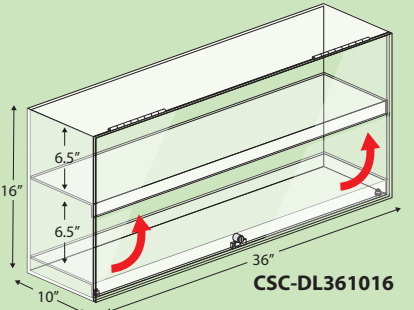

CSC-DL361016

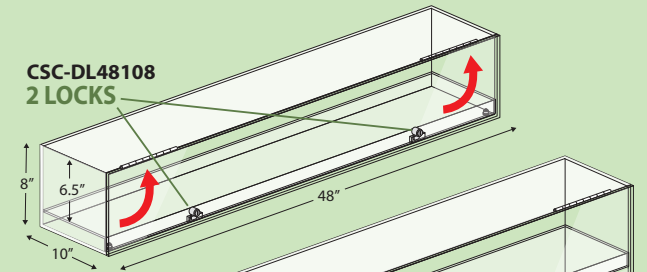

CSC-DL48108
2 LOCKS

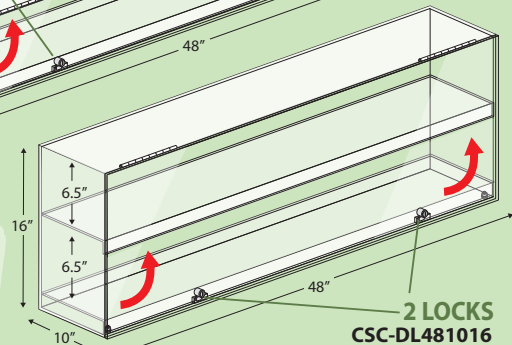

2 LOCKS
CSC-DL481016



Our gondola displays are environmentally friendly unlike disposable plastic merchandising strips.

Premium Security Cases

OFF THE GONDOLA
Lockable Plastic Cases



With Sliding Door and UPC Shelf Edge

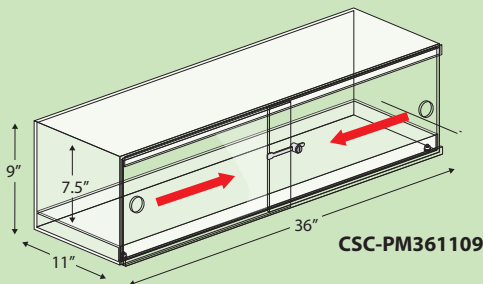
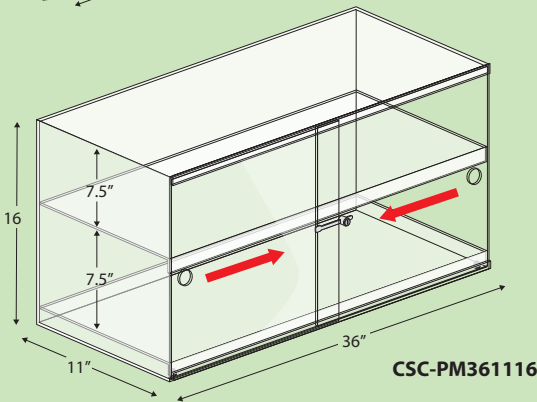
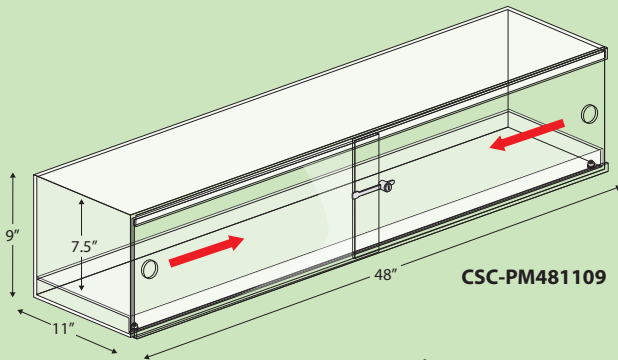
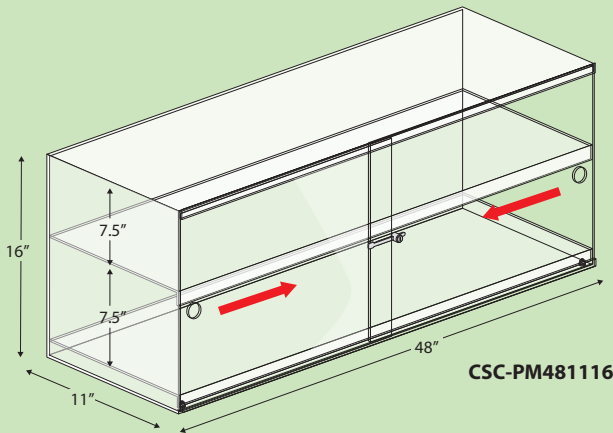

CSC-PM481109
48" Wide x 11" Deep x 9" Tall



Ask About Our Front Rails, Product Dividers, and Data Strips

- Key Lock Easy-access with various style door openings.
- Durable clear 1/4" acrylic construction.
- All cases bolt down to shelf. Fasteners Included.
- Low profile dividers keeps items organized.
- Optional Data Strips with adhesive for paper UPC labels and printed graphics can be applied to our Deluxe and Premium models.

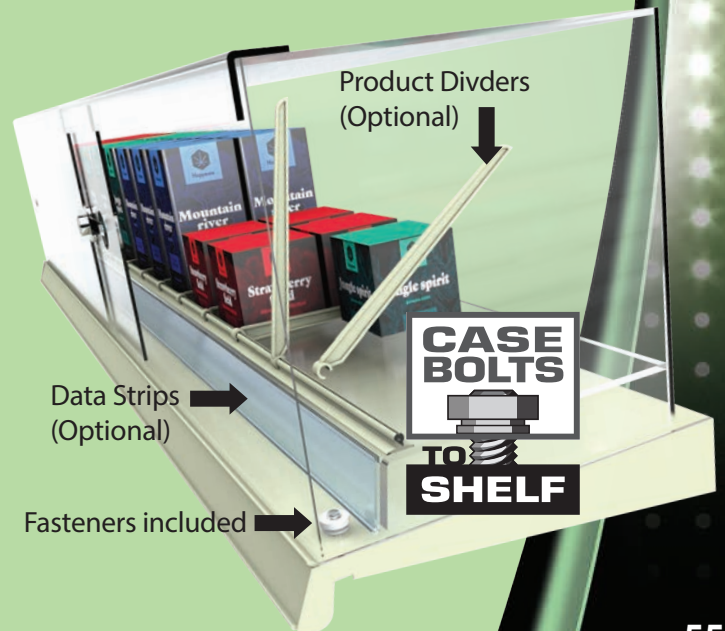

800.992.5233 • email: hq@tmshea.com

Plastic Hooks

PEG HOOKS

For SwingStrips,
PowerStrips,
or thin material

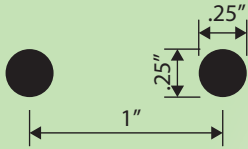

Fits this Slot



PSH-1A
1" Peg Hook



PSH-3BA
3" Butterfly Peg Hook



PSH-2SA
2" Peg Hook with Scan Plate



PSH-2SFA-W
2" Peg Hook
with Flip Scan Plate

PSH-2A
2" Peg Hook

PSH-4BA
4" Butterfly Peg Hook

PSH-4SA
4" Peg Hook with Scan Plate

PSH-4SFA-W
4" Peg Hook
with Flip Scan Plate

PSH-4A
4" Peg Hook

PSH-6BA
6" Butterfly Peg Hook

PSH-6SA
6" Peg Hook with Scan Plate

PSH-6SFA-W
6" Peg Hook
with Flip Scan Plate

PSH-6A
6" Peg Hook

PANEL HOOKS

For B-Flute,
E-Flute cardboard,
or thin cardboard/
panel material

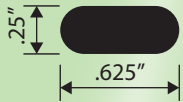

Fits this Slot



PPH-1
1" Panel Hook



PPH-2B
2" Butterfly Panel Hook



PPH-2S
2" Panel Hook with Scan Plate



PPH-4BS
4" Butterfly Peg Hook
with Scan Plate

PPH-2
2" Panel Hook

PPH-3B
3" Butterfly Panel Hook

PPH-3S
3" Panel Hook with Scan Plate

PPH-6BS
6" Butterfly Peg Hook
with Scan Plate

PPH-4
4" Panel Hook

PPH-6B
6" Butterfly Panel Hook

PPH-4S
4" Panel Hook with Scan Plate

PPH-6
6" Panel Hook

PPH-6S
6" Panel Hook with Scan Plate



MagnaGrips



PS-SGMAG
1" Non-Flexible
MagnaGrip
Perpendicular
Holds up to 1/8" Material

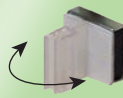

PS-SG1FMAG
1" Flexible
MagnaGrip
Holds up to
1/8" Material



PS-SG2MAG
1" MagnaGrip
Parallel
Holds up to
1/8" Material

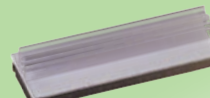

PS-SG6MAG
3" Non-Flexible
MagnaGrip .125"
Holds up to 1/8" Material

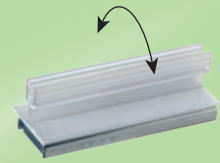

PS-SGFMAG
3" Flexible
MagnaGrip .125"
Holds up to 1/8" Material

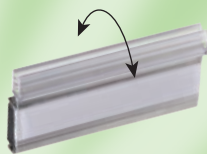

PS-SG7FMAG
3" Flexible Side Mount
MagnaGrip .125"
Holds up to 1/8" Material

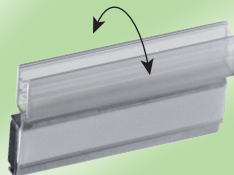

PS-SG8FMAG
3" Flexible Side Mount
MagnaGrip .25"
Holds up to 1/4" Material

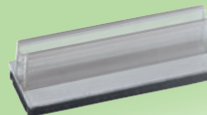

PS-SG7MAG
3" Non-Flexible
MagnaGrip .25"
Holds up to 1/4" Material

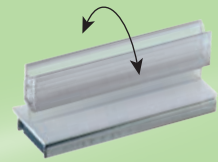

PS-SGFLMAG
3" Flexible
MagnaGrip .25"
Holds up to 1/4" Material

Sign Grips



PS-SG
1" Super Grip with Adhesive



PS-SG2
1" Super Grip with Adhesive for SwingStrip



PS-SG3
1" long



PS-SG4
3" Super H-Grip



PS-SG5A
1" Super Grip for SwingStrip



PS-SG6
3" Super Grip with Adhesive
Holds up to 1/8" Material



PS-SG7
3" Super Grip with Adhesive (Large)
Holds up to 1/4" Material



PS-SG8
with Adhesive 1" long



PS-SG9
for C-Channel



PS-SG10
for wire
PowerArms™



PS-SG11
for scan pegs & Paper
SEM labels



PS-SG12
Sign Grip for
Shelf Extender

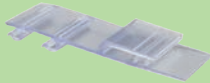

PS-WSG
for Wire Grids



PS-SG15
Flag Sign Holder
with adhesive



PS-SG19
1.5"W x 3"L Super Grip for
Thin Signs with Adhesive



PS-SG24
3" Sign Grip with Clamp
Mount of 5/8" - 3/4"



PS-SGF
3" Super Flex Grip
with Adhesive



PS-SGF2
3" Slip Over
Super Flex Grip
with Adhesive

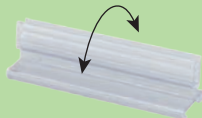

PS-SGFSL100
3" Slip Over Flex Sign Grip
Holds up to 1/8" Material

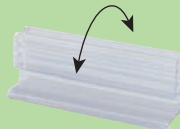

PS-SGFSL100250
3" Slip Over Flex Sign Grip
Holds up to 1/4" Material



Data Strip with
foam tape adhesive
2.0" - DATASTRIP2.0FT
2.5" - DATASTRIP2.5FT
3.0" - DATASTRIP3.0FT

Under-Shelf SwingStrip®

PS-SG3, PS-SG4

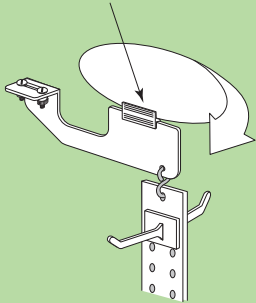

Adjustable PowerArm®

PS-SG, PS-SG6, PS-SG7

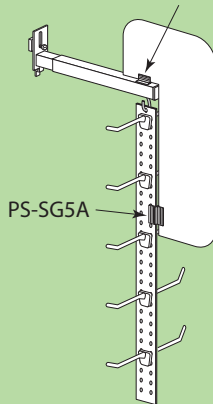

MagnaStrip

AMMOStrip™

PS-SG5A

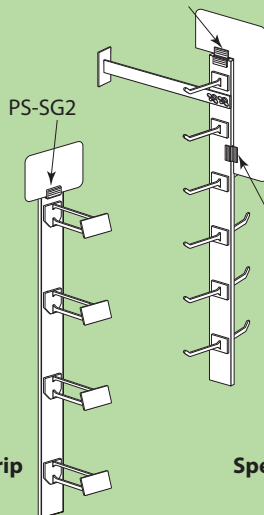

SpeedStrips™

PermaPanel®

PS-SG5A

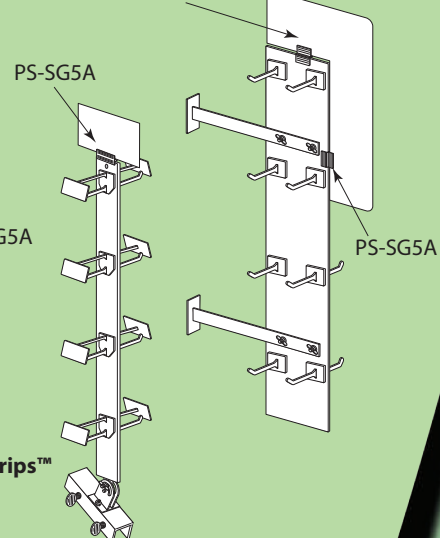

Floor Displays



PROBLEM

- One-sided floor displays consisting of different sizes, shapes, colors and materials.
- Restricted merchandising capabilities.
- Visual clutter.
- Promotional displays are difficult to move and easily fall apart.



SOLUTION

- Replace cardboard displays with PowerPillars™ for uniform merchandising.
- Durable floor spinner gives access to all products from any side.
- Accommodates a variety of pegged, boxed, bottled and bulk product.
- Graphics can be changed depending on seasonal requirements or category/brand strategies creating a more permanent display.

The above trademarks and those throughout this catalog are owned by the indicated companies and are not owned by T.M. Shea Products, Inc. The trademarks are being used in this catalog only for illustrative purposes and are not intended to indicate any other connection between these companies and T.M. Shea Products, Inc.



Why Our Floor Spinners Sell More

At TM Shea Products, we offer modular floor display systems because they look better and sell more product faster. Superior for merchandising throughout your store our floor displays offer a variety of accessories to hold an assortment of products. Peg hooks, shelves and dump bins allow you to merchandise a variety of products. They can be placed virtually anywhere in the store, and the graphics are infinitely customizable to create uniform P.O.S. messaging that matches your store décor/brand. Each display can generate hundreds of dollars in weekly incremental sales!

Mini PowerPillar™ Floor Spinners

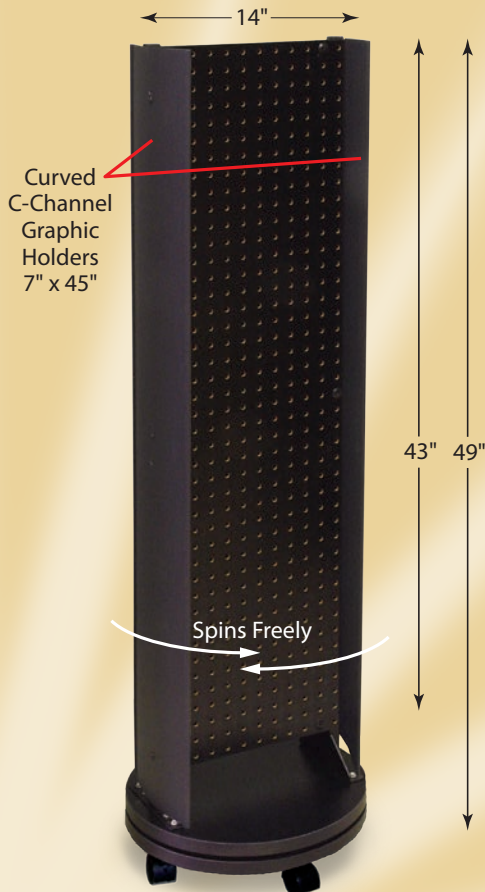

Black Peg Board Mini PowerPillar™
MPDQ-1448-P7

For peg hooks & accessories see pages 76-77



Maximize Sales/Profits in a Small Footprint with These 2 Sided Floor Spinners

- Mini PowerPillar™ is 48" tall with an 14" footprint and spins for easy shopping.
- Plan-o-gram floor space to create nearly an additional 8 sq. ft. merchandising and selling space.
- Spins for easy access to both sides.
- Locking casters or foot levelers available.
- Easily mount pre-packed cardboard shippers to display a variety of products in a small footprint.
- Accessories include peg hooks, shelves, dump bins and buckets.
- Custom header and side signs can be printed on various substrates.



800.992.5233 • email: hq@tmshea.com

PowerPillar™ Floor Spinners



18"

18"

Curved C-Channel Graphic Holders 7" x 48"

Curved C-Channel Graphic Holders 7" x 45"

PowerPillar™

without sign side channels
PDQ-1860-P

with 7" curved sign channels
PDQ-1860-P7

Low Profile PowerPillar

with 7" curved sign channels
PDQ-1848-P7

48"

42"

60"

48"

Spins Freely

Spins Freely

5 Swivel Casters (2 Locking)

5 Swivel Casters (2 Locking)

For peg hooks & accessories see pages 76-77



Display a Variety of Products with this Multi-Purpose Merchandiser

- “Lego-like-system” feature offers versatility to accommodate pegged, bottled, boxed and bulk product.
- Plan-o-gram floor space to create an additional 12 sq. ft. of merchandising and selling space.
- PowerPillar™ is 60” tall with an 18” footprint and five casters (two locking), and spins for easy shopping.
- Low Profile PowerPillar™ is 48” tall with an 18” footprint and five casters (two locking), and spins for easy shopping.
- Accessories include peg hooks, shelves, bulk bins and buckets.
- Custom die-cut graphics can be created to support a merchandising theme with matching store colors, seasonal/lifestyle graphics or brand artwork.



Econo PowerPillars™



Customized to Fit Your Needs and Budget

- Our basic version of Econo PowerPillar™ can be upgraded by adding sign channels, custom die cut graphics and/or a swiveling base.
- Plan-o-gram floor space to create an additional 12 sq. ft. of merchandising and selling space.
- Econo PowerPillar™ is 57" tall with an 18" footprint with or without a swiveling base.
- Accessories include peg hooks, shelves, dump bins and buckets.
- Custom die cut graphics can be created to support a merchandising theme with matching store colors, seasonal/lifestyle graphics or brand artwork.

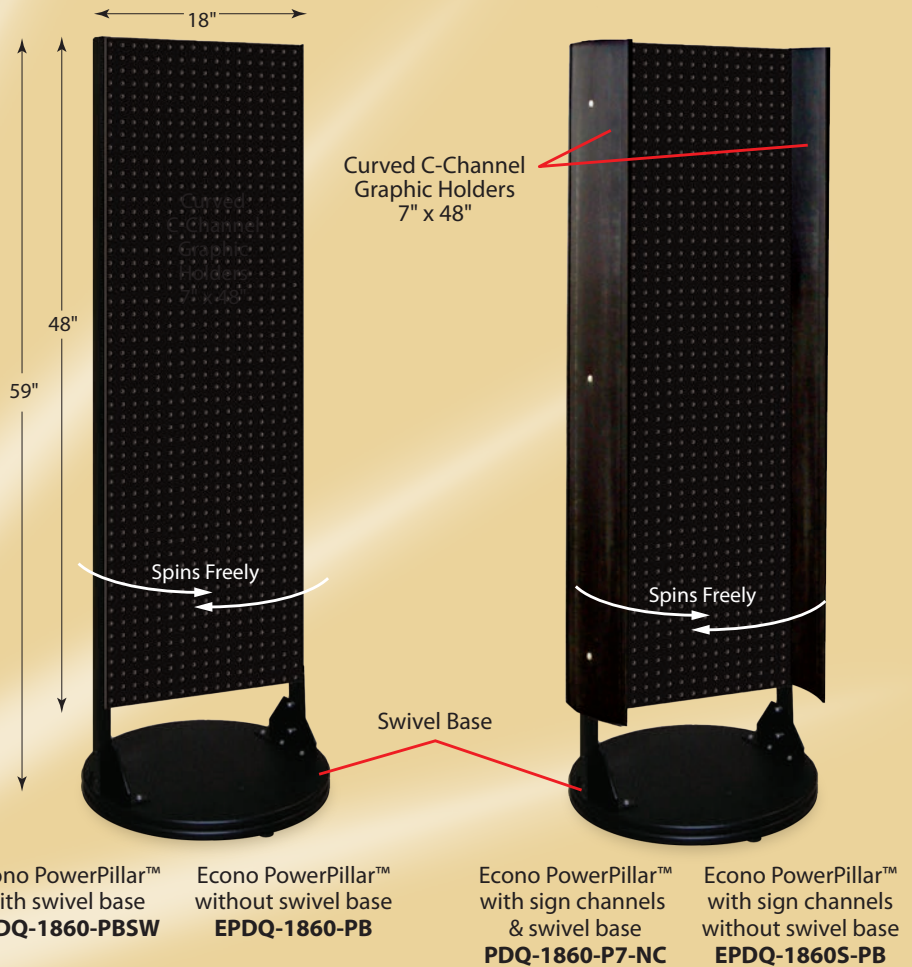

For peg hooks & accessories see pages 76-77

SideStackers™

ON THE FLOOR
Econo PowerPillars™ / SideStackers™

Protruding Header



Rear Mount Header



Rear Mount Header



Turn End Cap Sides Into Profit Centers

- Ideal for end cap side promotions and cross merchandising.
- Interchangeable accessories available to accommodate pegged, bottled, boxed and bulk products.
- Create additional merchandising and selling space:
 - 18" wide unit adds 6 sq.ft.
 - 24" wide unit adds 8 sq.ft.
- Accessories include peg hooks, shelves, dump bins, and buckets.
- Custom die-cut graphics can be created to match store colors or promote brands.
- Custom colors and sizes are available.



24" SideStacker™
ECS-2454-MWP



18" SideStacker™
ECS-1854-MWP

800.992.5233 • email: hq@tmshea.com

18" x 48" PowerGrids™

1 Sided 14" x 48" PowerGrid™



Patents Pending

2 Sided 14" x 48" PowerGrid™



Linked 2 Sided 28" x 48" PowerGrid™



Transformer Series

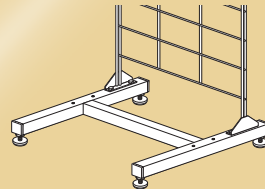

Rear Mount Grid
for 1-Sided Floor Display

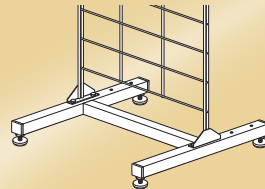

Center Mount Grid
for 2-Sided Floor Display

C-Channel Graphic Holders
10" x 45"

14" x 48" PowerGrid™
with 3" grid spacing
1-Sided Floor Display with
Rear Mounted Grid shown
With Casters: **PG-1448C-3-B**
With Levelers: **PG-1448L-3-B**

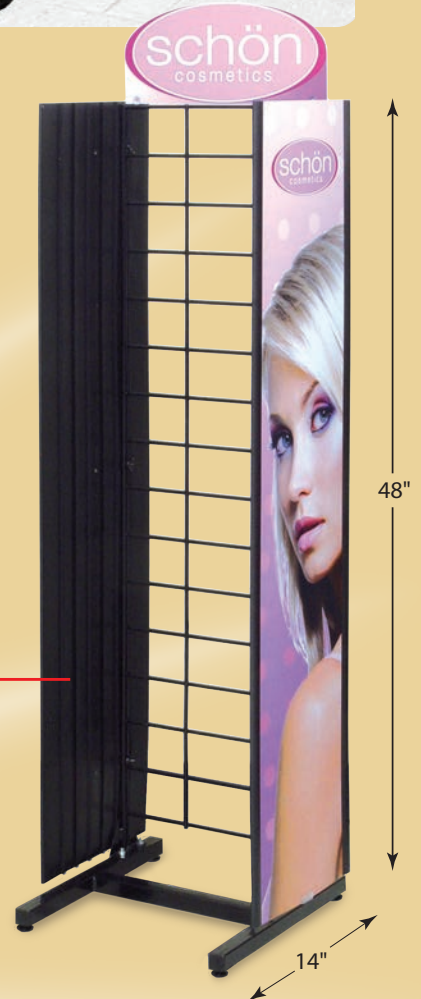

18" x 54" PowerGrids™

ON THE FLOOR
PowerGrids™

1 Sided 18" x 54" PowerGrids™



Linked 2 Sided 36" x 54" PowerGrid™



Create Solutions Centers with These 1 or 2 Sided Floor Displays

- Our new 3" wire PowerGrid Transformer Series offer 2 platform sizes to choose from; 14" x 48" and a 18" x 54".
(connect two 14" together to make 28" wide or connect two 18" to make 36" wide display)
- This new PowerGrid enables you to transform the display from a 2-sided merchandising center mount grid in open spaces, to a 1-sided back mount grid display that can be placed on the side of endcaps or against walls.
- The PowerGrids can ship fully assembled or unassembled. These displays are versatile and extremely durable.
- Accessories include peg hooks, shelves, dump bins and magazine pockets.
- Header and side signs can be easily changed out.
- Custom header and side signs prints various substrates.



4" PowerGrid Hook
PG3-4-B
6" PowerGrid Hook
PG3-6-B
8" PowerGrid Hook
PG3-8-B



4" PowerGrid Hook with Flip Scan
PG3-4S-B
6" PowerGrid Hook with Flip Scan
PG3-6S-B
8" PowerGrid Hook with Flip Scan
PG3-8S-B

C-Channel
Graphic Holders
10" x 51" or 10" x 48"

18" x 54" PowerGrid™
with 3" grid spacing
2-Sided Floor Display with
Center Mounted Grid shown

With Casters
PG-1854C-3-B
With Levelers
PG-1854L-3-B



For peg hooks & accessories see pages 76-77

800.992.5233 • email: hq@tmshea.com

1 & 2 Sided Lockable Floor Cases

1 Sided Locking Security Case



2 Sided Locking Security Case



Ideal for Safe & Secure Perimeter and Checkout Placement



48" Tall 1 Sided Floor Case
FSC-15H48

48" Tall 2 Sided Floor Case
FSC-25H48

60" Tall 1 Sided Floor Case
FSC-15H60

60" Tall 1 Sided Floor Case
FSC-25H60



Optional Foot Levels or Locking Casters



2-Sided Lockable Spinning Cases

ON THE FLOOR
Lockable Security Floor Displays



Stand Alone & Grab Everyone's Attention While Protecting Your Product

- Keep secure your CBD and other high dollar/high theft items.
- 20" x 48" or 20" x 60" tall with a 30" footprint spinner base system.
- Shelves adjust vertically to fit your merchandise
- Shelf edge has optional UPC data strip with adhesive for paper labels.
- Double lock and key system for extra security.
- Custom signage available or purchase stock program.
- Optional Foot levelers or locking casters.

48" Tall 2 Sided Spinner Case
FSC-25R48

60" Tall 2 Sided Spinner Case
FSC-25R60



60" / 72"
Available in 48" or 60"

800.992.5233 • email: hq@tmshea.com

Rotating Floor Display



Impulse Solutions for Boxed or Bottled Products

These displays will give you greater flexibility for merchandising high density sales in a small footprint. Placing these displays throughout the store will give you a uniform look and visual continuity.

- Includes hardware and sign holder
- 18" shelves can be vertically adjusted by using the hose clamp/washer system or through hole cotter pin
- Quick easy assembly

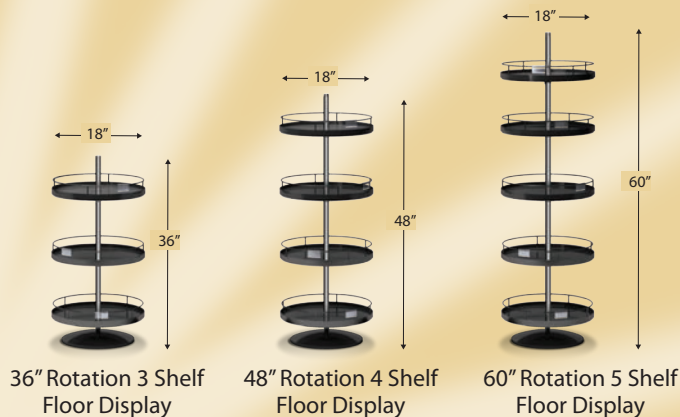

Our gondola displays are environmentally friendly unlike disposable plastic merchandising strips.

BucketTree Spinner Display

ON THE FLOOR
Rotating Floor Display / Bucket Tree



Boost Your Drive Aisle Impulse Sales & Profits

With a 16" diameter base, it can be placed anywhere on the sales floor and with countless bucket configurations, you can merchandise small and medium products alike. Adding a header sign to the display guarantees that the products will sell faster.

BucketTree
Customize Me To Fit Your Needs

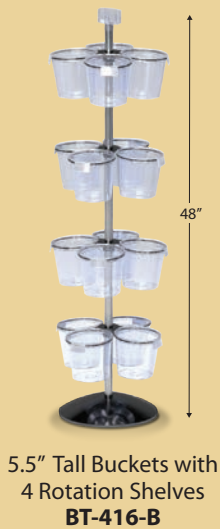

5.5" Tall Buckets with 4 Rotation Shelves
BT-416-B

Inquire About Our Shorter Buckets and Adding More Levels

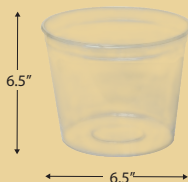

Crystal Clear Bucket
6.5" w x 6.5" d
B80

800.992.5233 • email: hq@tmshea.com

SpinStrip/SpinPanels



Deliver Great Impulse Sales Opportunities

Candy, snacks, seasonal, and GM/HBC products that will deliver high velocity, high margin sales and are great for anywhere in the store!

- SpinStrips are 1.5" wide x 48" tall
- SpinPanels are 5.5" wide x 48" tall
- 48" rigid metal rod with heavy base for stability
- A variety of peg hooks from 1" - 6" available with or without UPC/SEM label holders
- Ideal for low profile locations in tight spots
- Ships flat, assembles in seconds

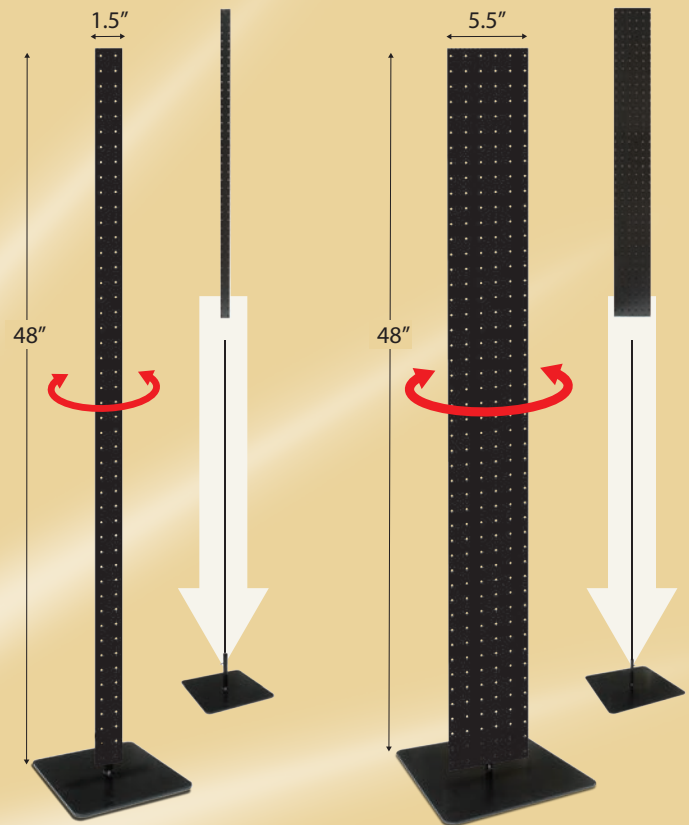

8" x 8" SpinStrip™
SS-1548

12" x 12" SpinStrip™
SS-1548



TriSpinners



Great Solutions for Small Spaces

These TriSpinners can be positioned along the racetrack / drive aisle perimeter, center store and check-out lanes.

- Custom designed / printed 3-sided Spinner Display
- 4" or 8" wide x 48" tall
- A variety of base sizes and colors
- A variety of peg hooks from 1" - 6" with and without UPC/SEM label holders
- Ideal for new product / seasonal / solution selling promotional price points

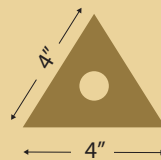

OR

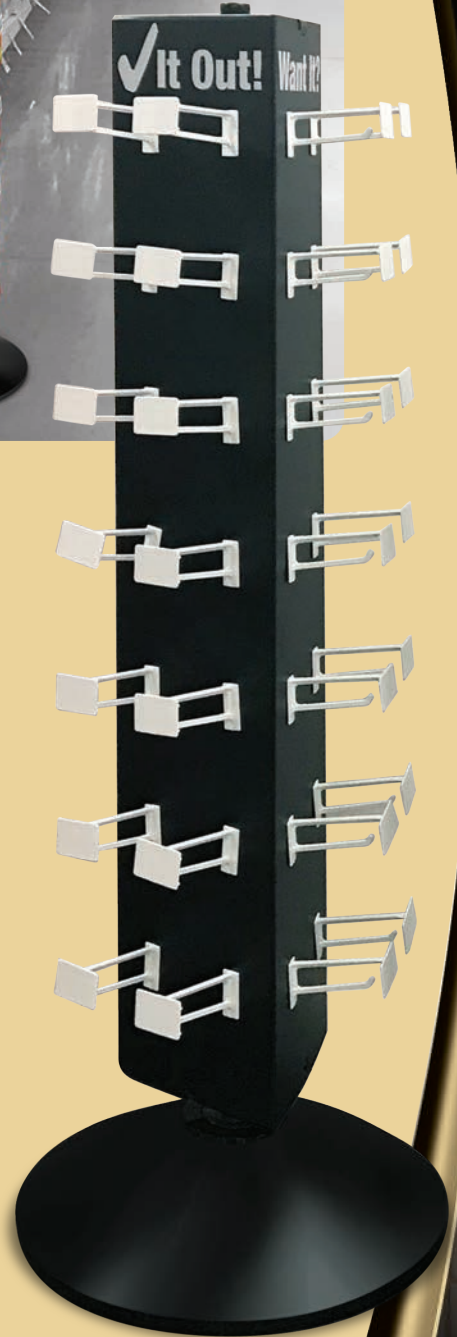
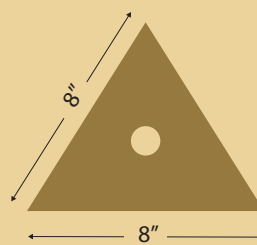

Circle

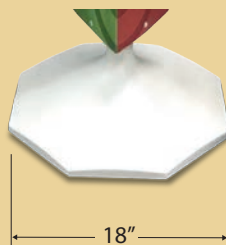

Octagon

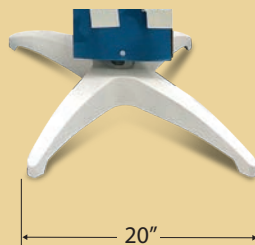

4 Legs

QuadSpinner Floor Display



P.O.P Options with Custom Printing

These new promotional displays gives shoppers new solutions and product introductions, while generating more sales and profits. Pulling center store products into the perimeter for customer promotions with your private label products and other new/seasonal products will deliver significant value.

- Spinning feature/Locking casters
- Great for checkout and perimeter placement
- 12" x 12" x 48" bulk bin on 18" footprint
- Multiple openings in the display for easy loading and shopping
- Custom printed panels store / promotion or brand / product promotion
- Optional foot levels or Casters

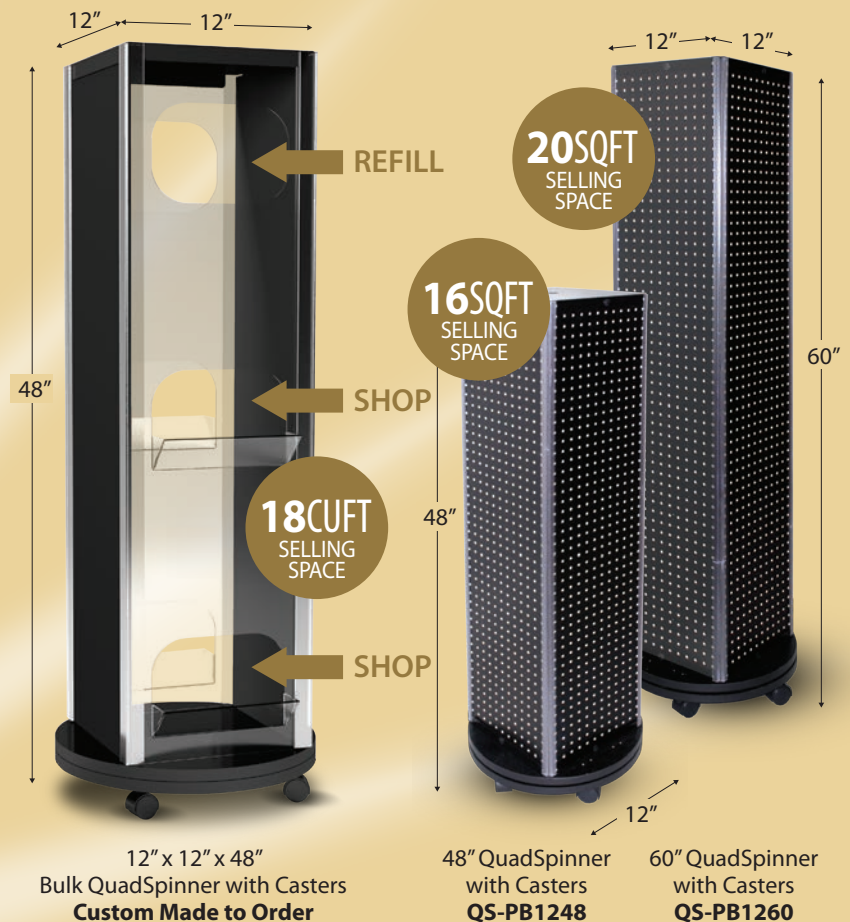

Many Display Options for You!



Perfect Placement for Perimeter and Checkout

Accessory options:

- Clear buckets
- Clear bins and clear shelves
- Wire shelves and wire bins
- Metal and plastic peg hooks with or without scan plate

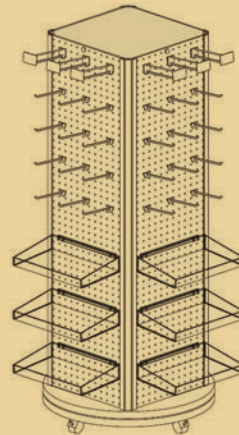

Plastic Pegs and Shelves

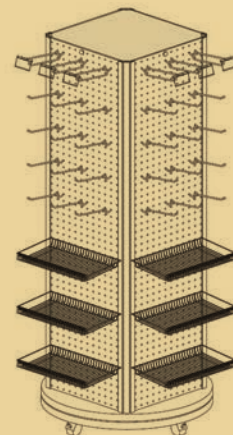

Metal Pegs and Shelves

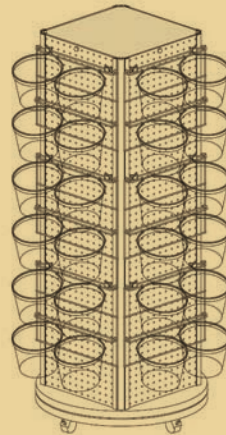

Clear Buckets

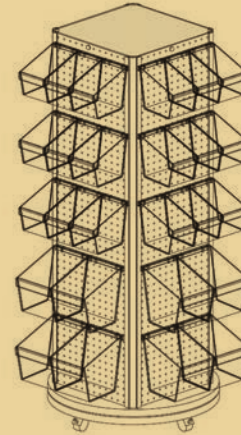

Plastic Dump Bins

Option A

Printed Square Sign with MagnaGrips

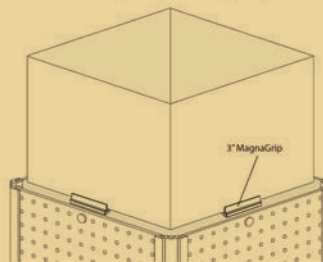

Option B

ClearView Sign Holders with MagnaGrips

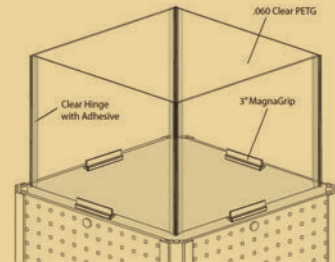

Option C

Flush Mount Signs with Push Rivets

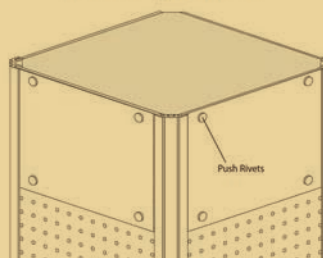

Option D

Flush Mount Signs with J-Channel Sign Tracks

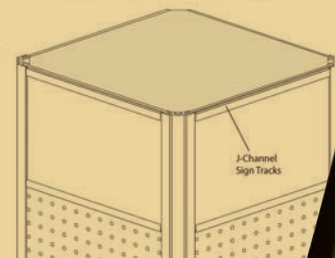

Floor Display Accessories

PEG HOOKS



MPWP-P4-B
4" Plastic Peg Hook



MPWP-P4S-B
4" Plastic Peg Hook with Flip Scan



MPWP-4
4" Metal Peg Hook



MPWP-4S
4" Metal Peg Hook with Flip Scan



MPWP-4-B
4" Metal Peg Hook



MPWP-4S-B
4" Metal Peg Hook with Flip Scan

MPWP-P6-B
6" Plastic Peg Hook

MPWP-P6S-B
6" Plastic Peg Hook with Flip Scan

MPWP-6
6" Metal Peg Hook

MPWP-6S
6" Metal Peg Hook with Flip Scan

MPWP-6-B
6" Metal Peg Hook

MPWP-8-B
8" Metal Peg Hook

MPWP-6S-B
6" Metal Peg Hook with Flip Scan

MPWP-8S-B
8" Metal Peg Hook with Flip Scan

Metal and Wire Grid Shelves

with plastic front runners for UPC/SEM labels

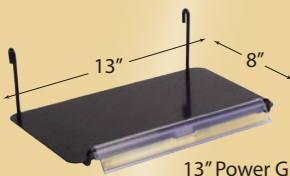

13" Power Grid Flat Shelf
PGSF-8X14-B

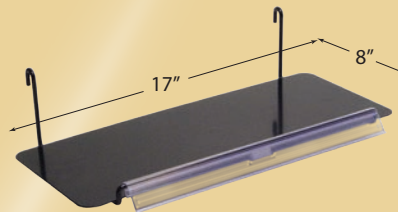

17" Power Grid Flat Shelf
PGSF-8X18-B

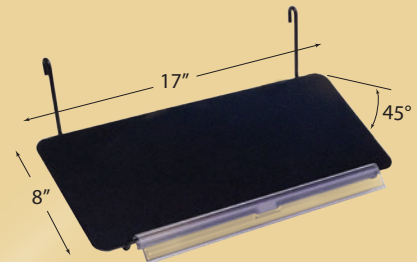

17" Power Grid Angled Shelf
PGSA-8X18-B

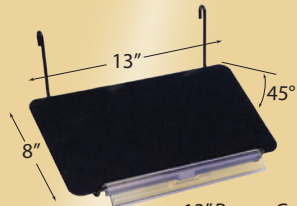

13" Power Grid Angled Shelf
PGSA-8X14-B

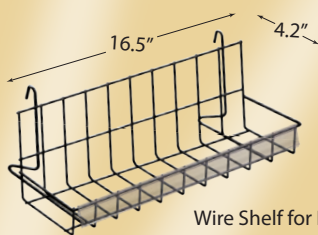

Wire Shelf for DVDs & CDs
WSB-1703-DVD-B

Pegboard / Wire Grid Baskets

with plastic front runners for UPC/SEM labels

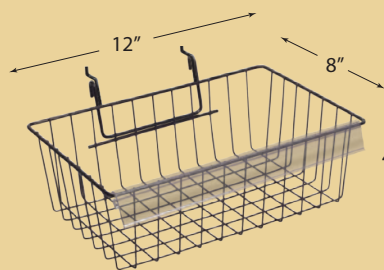

Small 12" Pegboard / Wire Basket
PGB-12X8X4-B

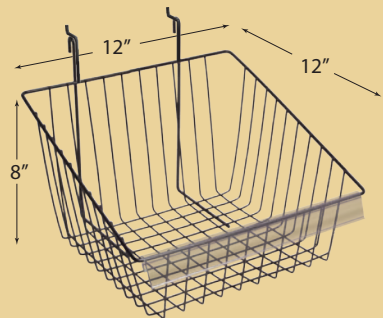

Large 12" Pegboard / Wire Basket
PGB-12X12X8-B

Pegboard Shelves

with plastic front runners for UPC/SEM labels

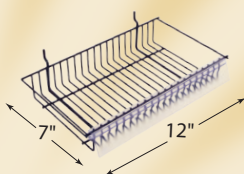

12" Wire Shelf
WS-0612BL-B

16" Wire Flat Shelf
WS-0716PBR-B

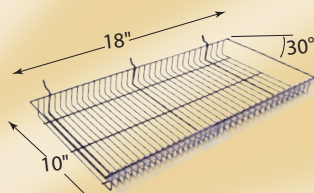

18" Angled Wire Shelf
WS-A1018-B

18" Wire Flat Shelf
WS-1018-B

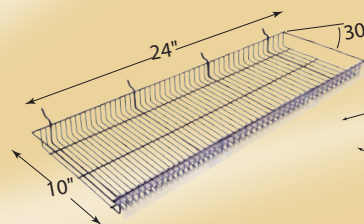

24" Angled Wire Shelf
WS-A1024-B

24" Wire Flat Shelf
WS-1018-B

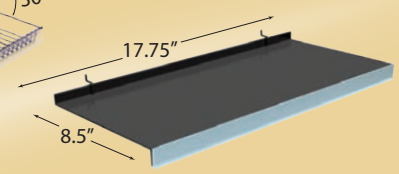

18" Lockable Case Shelf
FSC-1775825-B

Peg Board Accessories

Clear Plastic Dump Bins

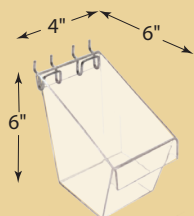

4" x 6" x 6"
PWP-PDB-466

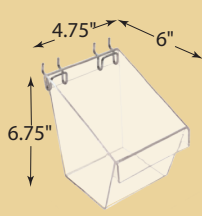

4.75" x 6.5" x 6.75"
PWP-PDB-4x6

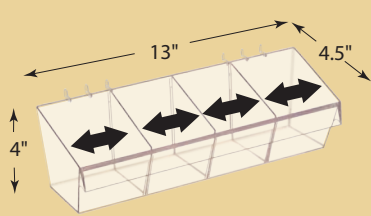

Small 4 Section Plastic Dump Bin
PWP-PPB-4513D

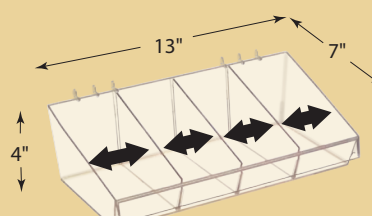

Large 4 Section Plastic Dump Bin
PWP-PPB-713D

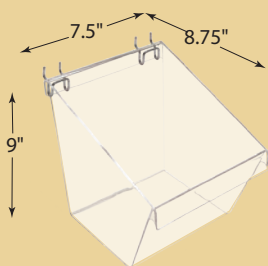

7.5" x 8.75" x 9"
PWP-PDB-7x8

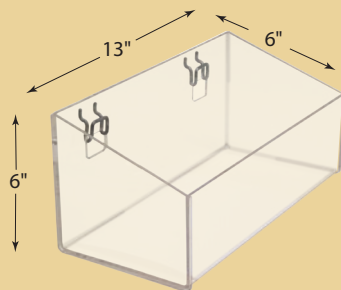

13" x 6" x 6"
PDP-13x6

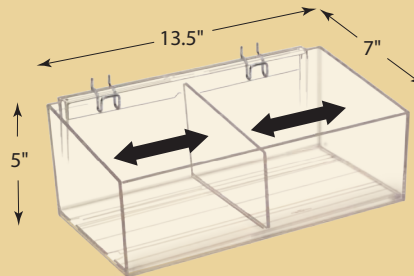

2 Section Plastic Dump Bin
PWP-PPB-7135D

Clear Plastic Shelves

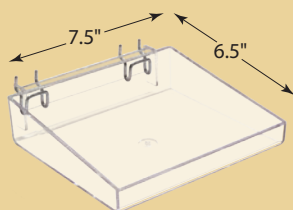

7.5" x 6.5"
PWP-SHF-7x6

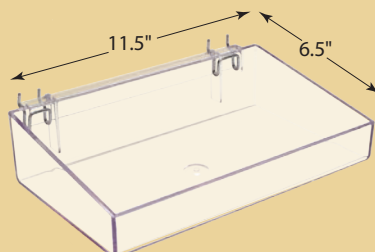

11.5" x 6.5"
PWP-SHF-11x6



Data Strip
with Adhesive
2.0" - **DATASTRIP2.0FT**
2.5" - **DATASTRIP2.5FT**
3.0" - **DATASTRIP3.0FT**

Crystal Clear Buckets



Crystal Clear Bucket 6.5" w x 6.5" d
B80



6.5" Pegboard Ring
TMS# BR6.5-B



Bucket Ring Scan Tag
ST-3

Peg Board BucketRax
PWP-BR-80BLK



Sign Systems



PROBLEM

A basic plan-o-gram that is visually unappealing with category locations not defined.



SOLUTION

Install high impact overhead signs and way finding category.

ArcArms™ to help shoppers find products faster and easier.

Give your department the "WOW!" factor and keep your customers shopping longer.

The above trademarks and those throughout this catalog are owned by the indicated companies and are not owned by T.M. Shea Products, Inc. The trademarks are being used in this catalog only for illustrative purposes and are not intended to indicate any other connection between these companies and T.M. Shea Products, Inc.





Overhead Sign Systems Take Plan-o-grams to a Higher Level

The easier it is for customers to find what they are looking for, the easier it is for them to buy your products. Enhancing the shopping experience is the idea behind our POG overhead sign systems. Dress-up your plan-o-grams to help shoppers navigate through aisles and locate products faster. This results in higher sales due to increased foot traffic. A combination of POG overhead signs and category ArcArms™ will complete your “store-within-a-store” concept by offering an upscale visual appeal that can include lifestyle imagery and brand graphics. Our overhead sign systems are easy to install and offer a big return on investment!

End Cap Promo Signs



Elevate Your End Caps with Visual Impact Signs

- Dress up your end caps with visually motivating signs that generate more foot traffic and sales.
- Help guide your shoppers through the aisles/departments.
- Create navigational wayfinding end caps.
- Exciting lifestyle visuals will capture their attention.
- Graphics can be created to match store décor, highlight a brand or emphasize a retail generic category.
- Creates visual speed bumps for shoppers.

For accessories see page 82





Navigational/WayFinding Promo End Caps

*For Hardware & Sign Options
See Page 82-83
(next Pages)*

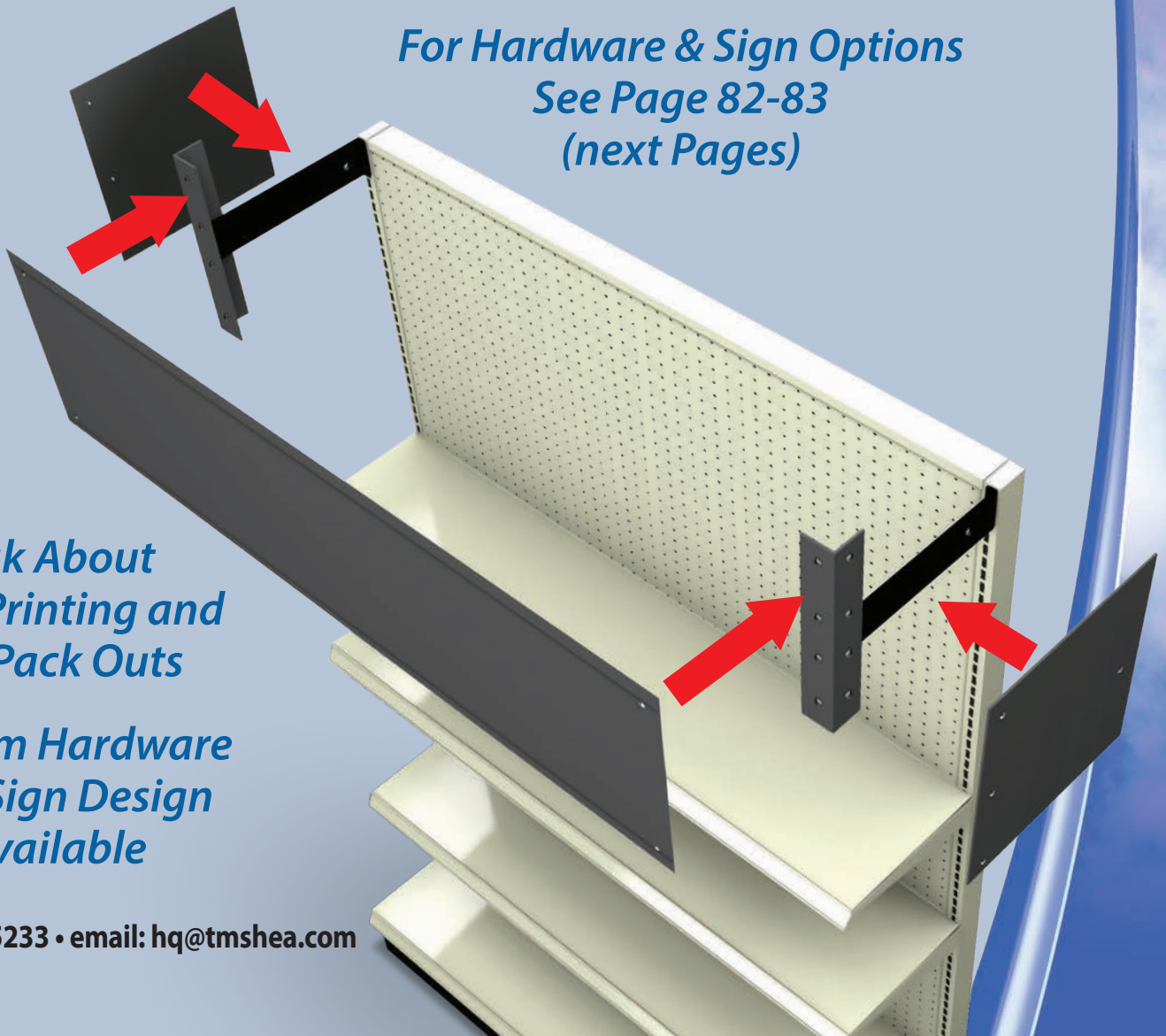

*Ask About
Sign Printing and
Kit Pack Outs*

*Custom Hardware
and Sign Design
Available*

800.992.5233 • email: hq@tmshea.com

Down Aisle Box Out Signs



Create Visual Excitement & Pull Shoppers Down Aisles

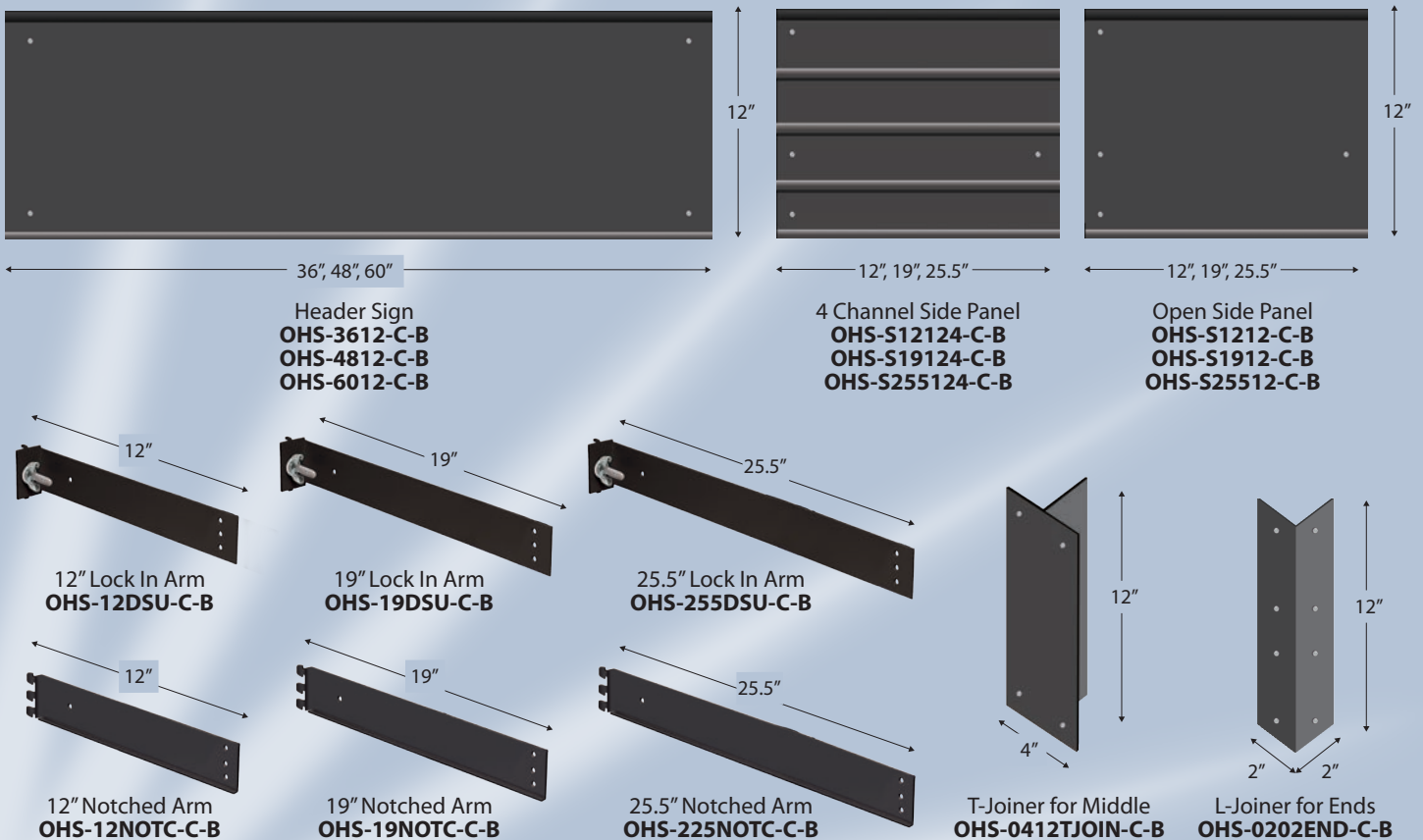

*Custom Hardware
and Sign Design
Available*

Color Code **I** **W** **G** **B**
Custom Colors Available

Down Aisle Valance Signs



*Ask About
Sign Printing and
Kit Pack Outs*

Highlight End Caps and Help Guide Shoppers

- Dress up your aisles with visually motivating signs that generate more foot traffic and sales.
- Keep your customers visually excited and keep them down aisle shopping longer.
- Graphics can be created to match store décor, highlight a brand or emphasize a retail generic category.

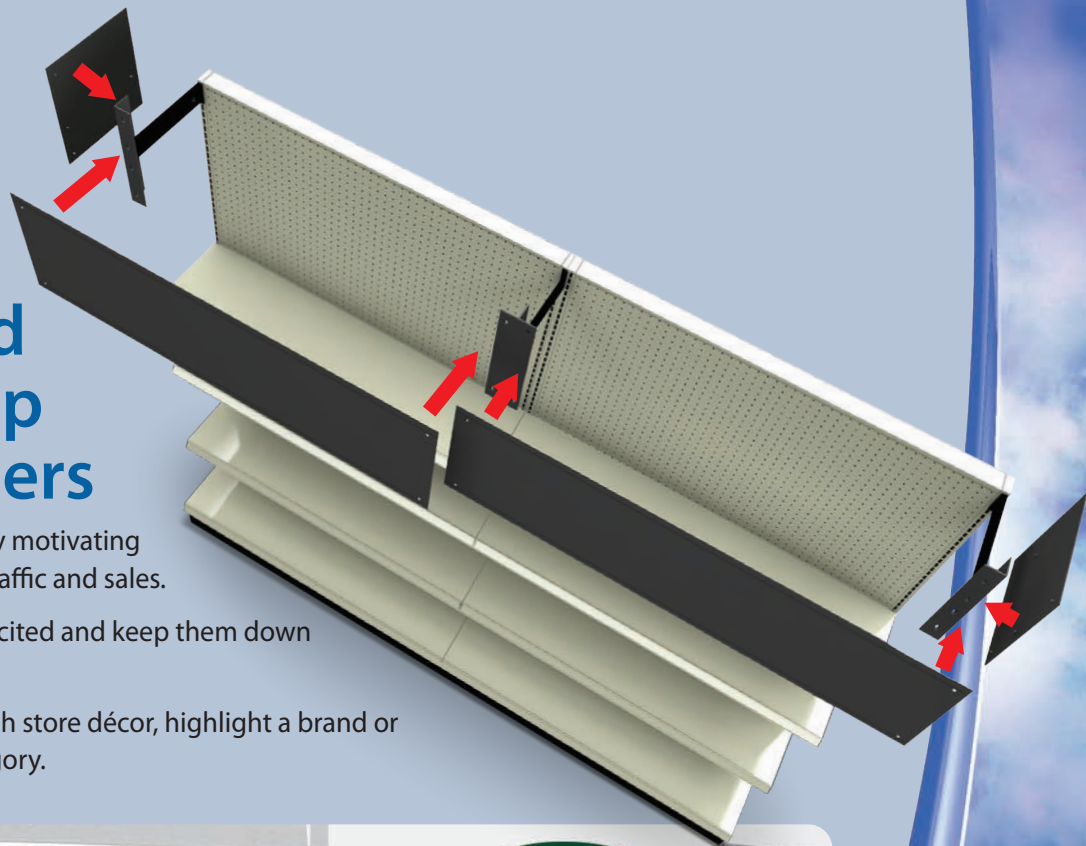

800.992.5233 • email: hq@tmshea.com

Top Rail Mount Sign Systems



Magnet Mount Sign Channel
White
5.25" x 34": **LPS-TR534-MAG**
5.25" x 46": **LPS-TR546-MAG**



Clamp Mount Sign Channel
Mounts on 2.5" Lozier & Madix
White
12" x 36": **LPS-TR1236-L**
12" x 48": **LPS-TR1248-L**

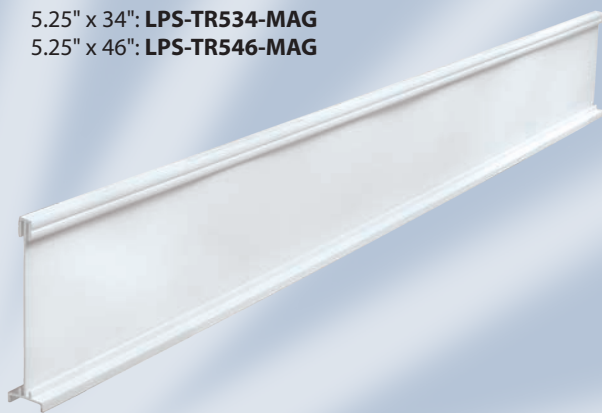

Clamp Mount Sign Channel
Mounts on 2.5" Lozier & Madix
White
5.25" x 36": **USM-TRMNT-LM**

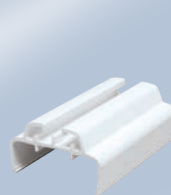

Pop-Out
Graphic
Bracket with
Adhesive
LPS-GPO

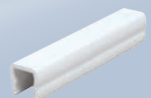

2-Sided Sign
Joiner
LPS-JOINER



Pop-Outs & Pop-Ups Create Visual Excitement

- Dress up your plan-o-gram with visually motivating signs that generate more foot traffic and sales.
- Turn-key sign systems stimulate customer interest in departments.
- Heighten brand awareness.
- Graphics can be created to match store décor, highlight a brand or emphasize a retail generic category.

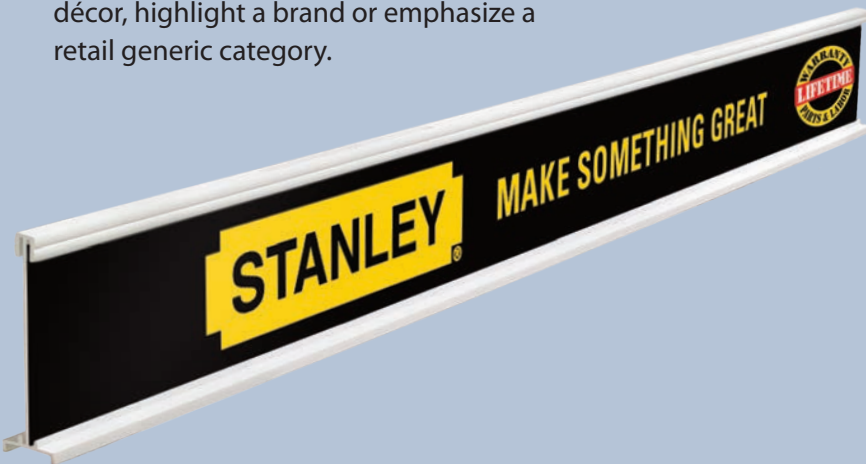

800.992.5233 • email: hq@tmshea.com

Overhead Sign Systems



Plastic C-Channel Header

Adjustable Extension Arms



3 Mount Positions

Custom Lengths Available

Flat Sign Channel holds 10.5" x 48" graphic Ivory or Silver
OHS-1048-EXT-IV

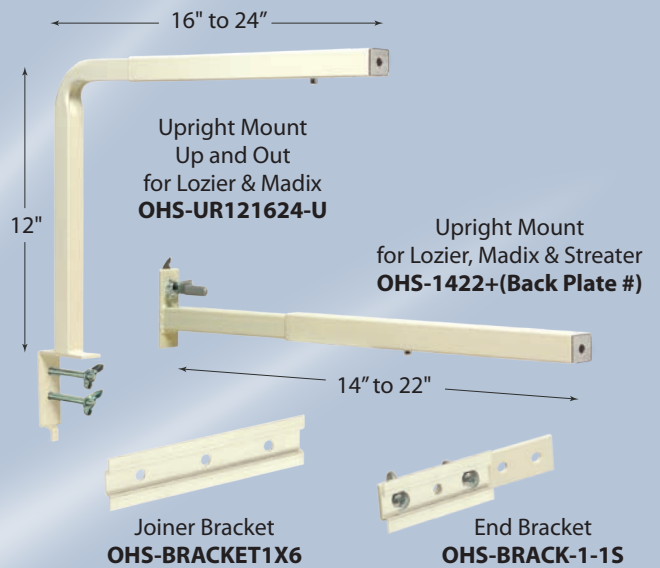

Add Back Plate Code to Part Number

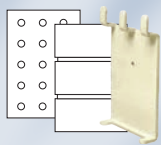

Pegboard and 3" Slat Wall
PB

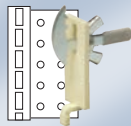

Single Slotted Upright
SS1

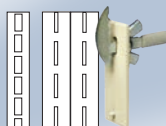

Single & Double Slotted Upright
DSU1

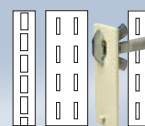

Universal 1-2 Slotted Uprights
DSU2



Pegboard Adapter for DSU PowerArms
PS-NPBBP-IV



Patents Pending



Increase Foot Traffic & Sales

- Design destination departments to increase foot traffic.
- Assist shoppers in finding products faster, therefore enticing them to buy more.
- Complete the store-within-a-store concept for extra visual appeal.
- Unique custom graphics with lifestyle photos and catch-phrase tag lines, brand graphics or category call-outs enhance the overall look of departments.
- Pop-outs include 1" foam blocks with adhesive on two sides.

800.992.5233 • email: hq@tmshea.com

Overhead Sign Systems



- Telescoping tubular arms extend out or up and out from uprights.
- Create a unique look to highlight special categories and departments.
- Complete the store-within-a-store concept for extra visual appeal.

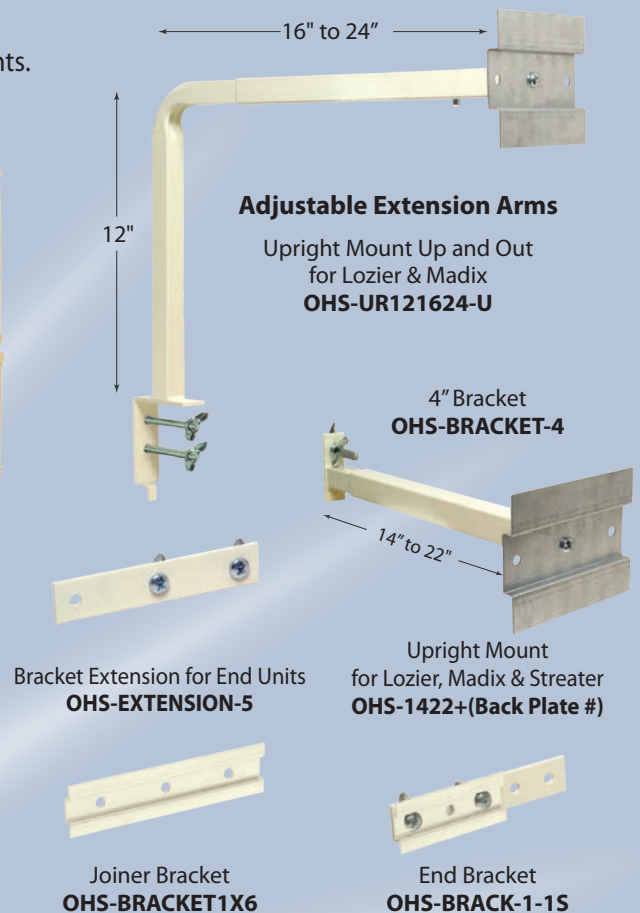

Add Back Plate Code to Part Number

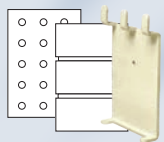

Pegboard and 3" Slat Wall
PB

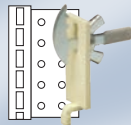

Single Slotted Upright
SS1

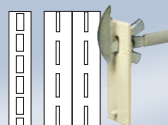

Single & Double Slotted Upright
DSU1

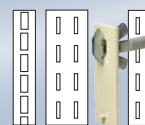

Universal 1-2 Slotted Uprights
DSU2



Pegboard Adapter for DSU PowerArms
PS-NPBBP-IV

Angled Overhead Signs



Create Visually Exciting Aisles

- Entice shoppers to keep shopping longer.
- Mounts off of uprights and can be positioned flush or above top rails.
- Ideal for highlighting categories down the aisle.
- Create a mood with lifestyle images.
- Easy to change out signs.



Ghost Brackets

End Cap Header with Aisle Category



Angled Down Aisle Box-Out Sign



Clear Plastic Bracket Sign Systems

- The bottom of header sign rest 3", 6", or 12" above gondola top rail.
- 16" or 20" is the distance from the back wall extending out to the bottom of header sign.

UNIVERSAL LEFT/RIGHT MIDDLE CONNECTOR



16" FLAT
Ghost Bracket

20" FLAT
Ghost Bracket

16" ANGLED
Ghost Bracket

20" ANGLED
Ghost Bracket

3" ABOVE GONDOLA

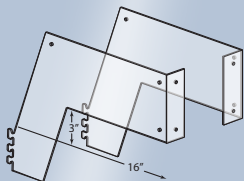

OHS-GBF0316-L OHS-GBF0316-R

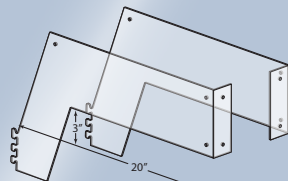

OHS-GBF0320-L OHS-GBF0320-R

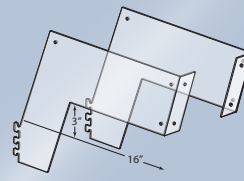

OHS-GBA0316-L OHS-GBA0316-R

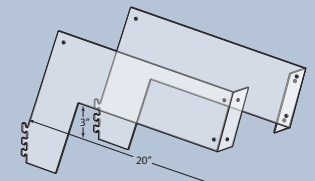

OHS-GBA0320-L OHS-GBA0320-R

6" ABOVE GONDOLA

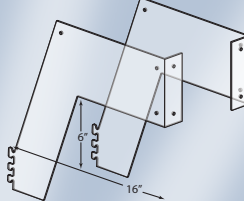

OHS-GBF0616-L OHS-GBF0616-R

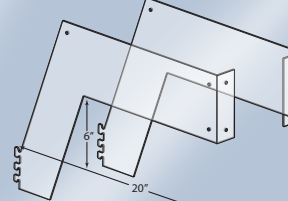

OHS-GBF0620-L OHS-GBF0620-R

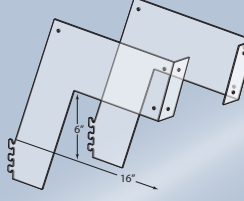

OHS-GBA0616-L OHS-GBA0616-R

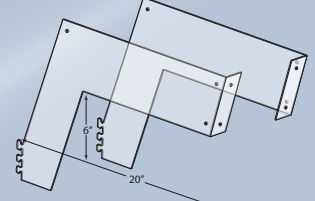

OHS-GBA0620-L OHS-GBA0620-R

12" ABOVE GONDOLA

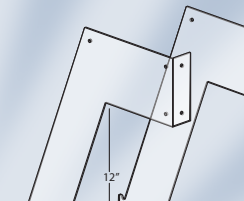

OHS-GBF1216-L OHS-GBF1216-R

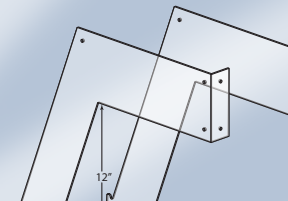

OHS-GBF1220-L OHS-GBF1220-R

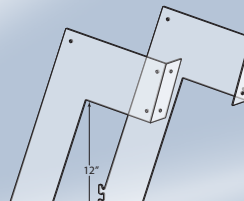

OHS-GBA1216-L OHS-GBA1216-R

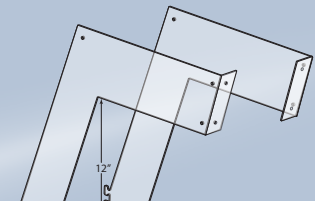

OHS-GBA1220-L OHS-GBA1220-R



Clear Plastic Bracket Sign Systems

- Mount on end caps, continuously down aisle, or as box-out sections in aisle POG.
- Assist shoppers in finding products with end cap category signs.
- Unique custom die-cut graphics with 3D pop-outs add a dramatic effect to your signage.
- Clear plastic brackets mount to uprights.
- Custom signs are available in high density foam core, ultraboard, or other rigid material.

Clear .125" PETG

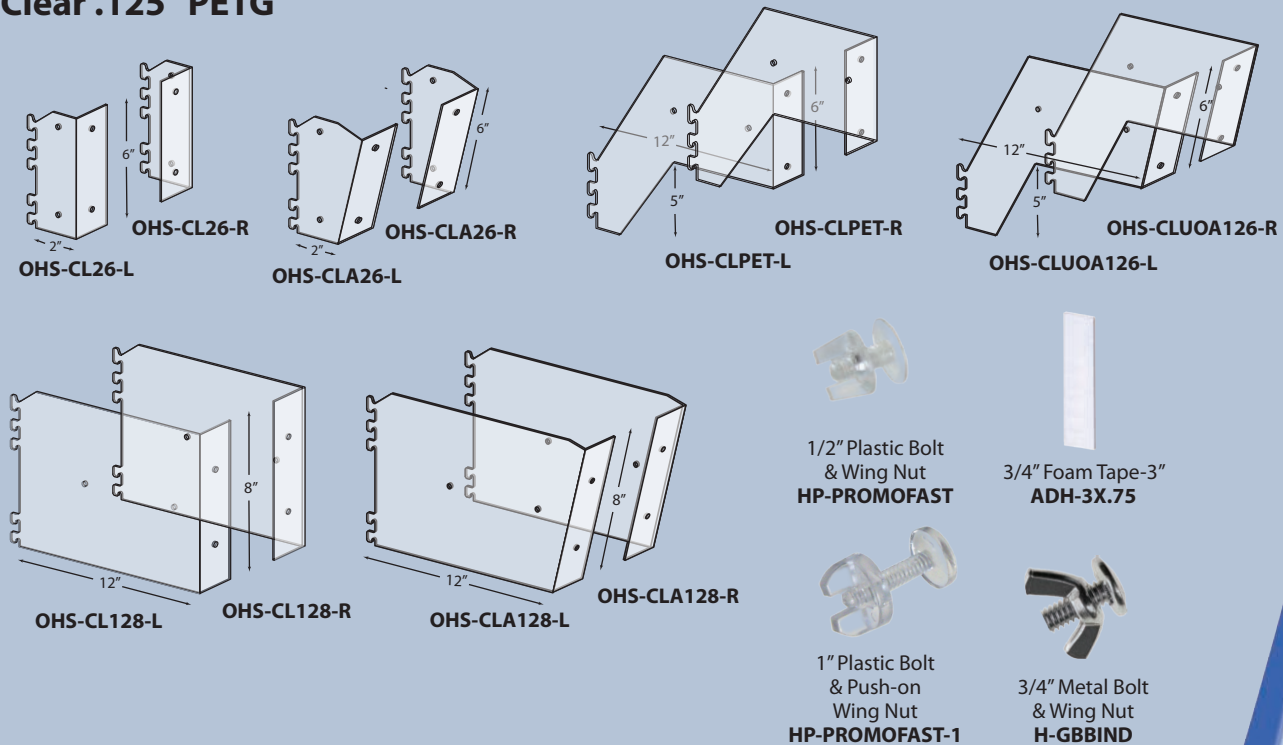

Flush Mount Signs



Mounting Channel

12" Flat Sign Channel holds 12" x 48" graphic
OHS-1248EXT-T
holds 12" x 36" graphic
OHS-1236EXT-T

Combine Extrusions with Tongue & Groove

Mounting Channel

8" Flat Sign Channel holds 8" x 48" graphic
OHS-0848EXT-T

Peg Board Mount

Large Channel Pegboard Mount Bracket & Plastic Rivet
OHS-BRACK-4RIV

3 Mount Positions

Flat Sign Channel holds 10.5" x 48" graphic
Ivory or Silver
OHS-1048-EXT-IV

Upright Mount Bracket Left Side
OHS-BRACKET-L

Up-Right Slot Mount

Upright Mount Bracket Right Side
OHS-BRACKET-R

Peg Board Mount

Small Channel Pegboard Mount Bracket & Plastic Rivet
OHS-BRACK-1RIV

Create Visual Excitement



Right or Left Slot Mounting with Sign Channel

5.25" Upright Slot
Mount Bracket
LPS-FMUNI-5JOIN

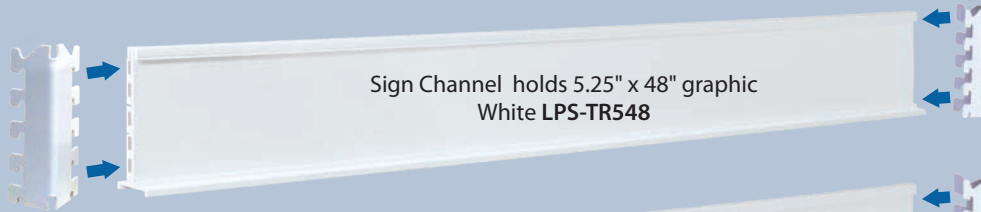

Sign Channel holds 5.25" x 48" graphic
White **LPS-TR548**

8" Upright Slot
Mount Bracket
LPS-FMUNI-8JOIN

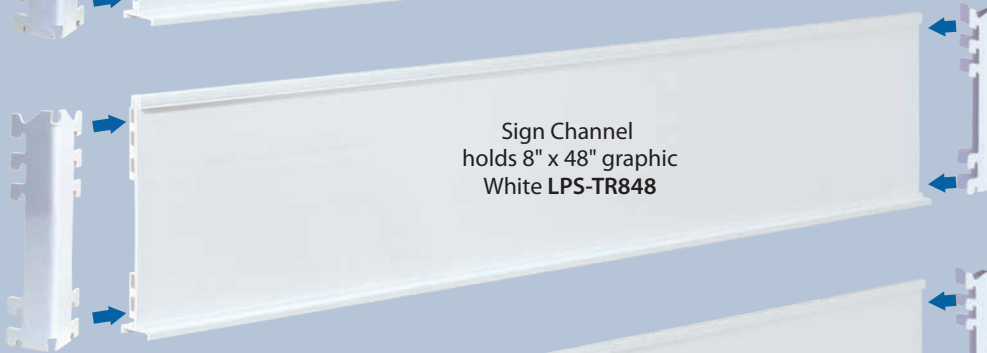

Sign Channel
holds 8" x 48" graphic
White **LPS-TR848**

12" Upright Slot
Mount Bracket
LPS-FMUNI-12JOIN



Sign Channel
holds 12" x 48" graphic
White **LPS-TR1248**

ClearView Sign Holders



Create Visually Exciting Interruptions

- Ideal for new product promotions.
- Use to inform or educate customers.
- Create a mood with lifestyle images.
- Easy to shop around.
- Universal mounting system for horizontal or vertical formats.
- Mounts off walls and top rails.
- Easy to change out signs.

.060" PETG Mount with opened edge up or down



4" High
Clear Plastic
36": OHS-CH-436
48": OHS-CH-448



4" High
Non-Glare Matte Finish
36": OHS-CHNG-436
48": OHS-CHNG-448



6" High
Clear Plastic
36": OHS-CH-636
48": OHS-CH-648

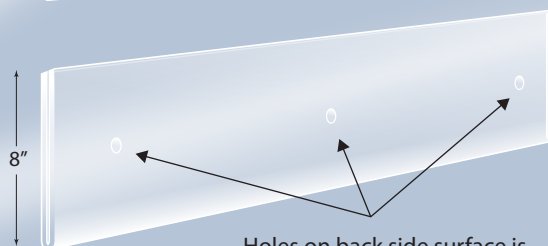

8" High
Clear Plastic
36": OHS-CH-836
48": OHS-CH-848

8" High
Non-Glare Matte Finish
36": OHS-CHNG-836
48": OHS-CHNG-848



Flush Mount Plastic Rivet
OHS-RIVET



Peg Board Wire Loop Bracket
OHS-CLIP

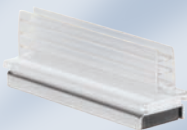

Magnetic Sign Grip
3" long holds 1/4" material
PS-SG6MAG

2-Sided End Cap Signs



Create Shopper Awareness

- Easy change out system at a lower cost.
- Versatile top rail mounting options allow for clamps (Lozier/Madix only) for quick installation.
- Extrusions hold either 11" or 7" signs with 4" header signs on front and 15" or 11" signs on back side.
- Add die cut pop-out signs for extra flair.



7" Sign Channel
Clamp Mount for 2.5" Lozier & Madix
Custom Cut to 48", 36", 24" or 18"
ECS-12SPIR-(L)



11" Sign Channel
Clamp Mount for 2.5" Lozier & Madix
Custom Cut to 48", 36", 24" or 18"
ECS-16SPIR-(L)

Blade Sign Holders



Adjustable Arm with 24" Sign Holder



Adjustable Arm with 36" Sign Holder



Adjustable Arm with 48" Sign Holder



2-Sided Blade Sign Holders

- Great for brand marketing, advertising, promotional messaging, and category call-outs.
- Mounts into slotted uprights of pegged or shelved sections.
- Arm telescopes from 12" to 22" or 16" to 26".
- Signs change out quickly.
- Custom printing and kit pack- outs available.



2-Sided Blade Sign Holder
24" x 5.25"
OHS-524J



2-Sided Blade Sign Holder
36" x 5.25"
OHS-536J



2-Sided Blade Sign Holder
48" x 5.25"
OHS-548J

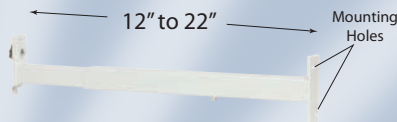

Adj. PowerArm 12"-22" White
OHS-1222FP-(Back Plate)

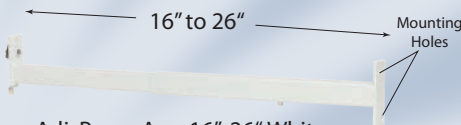

Adj. PowerArm 16"-26" White
OHS-1626FP-(Back Plate)

Add Back Plate Code to Part Number

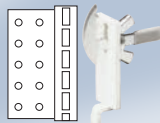

Tool Free Single Slotted Upright
SS1

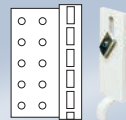

Single Slotted Upright
SS

Vertical Sign Posts

NEW

IN THE AIR
Blade Sign Holders / Vertical Sign Posts



Frame Out Special Sections or Highlight End Caps

- Sign systems pivot and flex out of the way for shoppers. Signs change out quickly.
- Ideal for use on end caps and down aisle.
- Great for brand marketing / advertising promotional messaging.
- We offer a variety of under and over shelf bracket systems, adjustable and fixed arms for pegged sections.
- A variety of clear plastic sign holders and extrusions are available.
- Custom printing and kit pack outs available.



Adjustable 12"-22"
PowerArm™ with U-Plate
OHS-1222XX-BRK-X



Sign Channel
Off Shelf Bracket
OHS-SEBRK-X



Includes
mounting
hardware

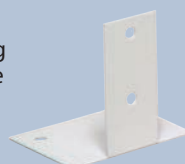

Sign Channel
Base Deck Shelf Bracket
OHS-SEBRKBT-X



4" Wide Sign Channel
36": **OHS-0436EXT-X**
48": **OHS-0448EXT-X**

Plastic Crescent Signs

Pegged Sections



Shelving



Refrigerator/Freezer Doors



Adjustable 1" Tube PowerArm with L-Bracket
CS-1222DSU+(color)



Adjustable 3/4" PowerArm with L-Bracket
CS-1222DSU34+(color)

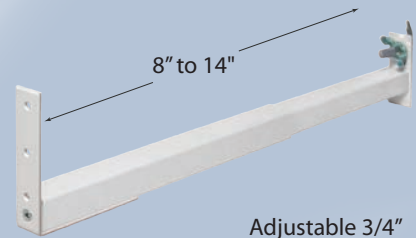

Adjustable 3/4" PowerArm with L-Bracket
CS-814DSU34+(color)



Includes mounting hardware

Adjustable Off Shelf Bracket
OHS-SEBRK-X

Off Shelf Bracket
OHS-SEBRKBT-X



Magnetic Mounting Hardware

Adhesive Mounting Strip



Suction Cup Mounting Hardware
H-SUCTION2

Add Back Plate Code to Part Number

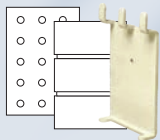

Pegboard and 3" Slat Wall
PB

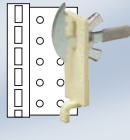

Single Slotted Upright
SS1

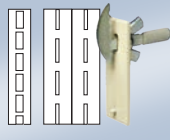

Single & Double Slotted Upright
DSU1

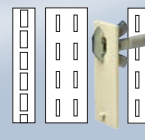

Universal 1-2 Slotted Uprights
DSU2



Pegboard Adapter for DSU PowerArms
PS-NPBBP-IV

Off End Caps and Down the Aisle

NEW



Call Out Categories or Create Brand Awareness

- These new Crescent Sign holders are ideal for private label brands, to drive promotions and launch new products. They are also great for high density SKU POG's for category call-outs like the OTC department.
- Crescent Signs mount off shelf and pegged sections with metal brackets. We also have magnetic designs for gondola side rails and suction cups for cooler/freezer door applications.
- Custom design, printing and kit packing.
- Standard sizes: 8" x 4", 12" x 4", and 8" x 6"



800.992.5233 • email: hq@tmshea.com

Shelf Sign Holders

NEW



Ideal for Product Promotions/Advertising, Educational Information, and for Category Locator Signs

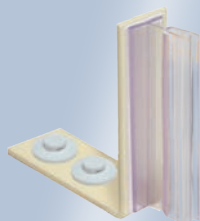

Over Shelf Bracket
PP-OSPERMFLEX

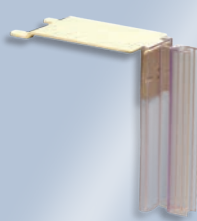

Metal Off Shelf Bracket
PP-OSBFLEX

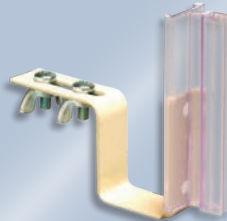

Under Shelf Bracket
PP-USBFLEX



C-Channel Bracket
PP-CCBFLEX



Pallet Rack Bracket
PP-PRFLEX

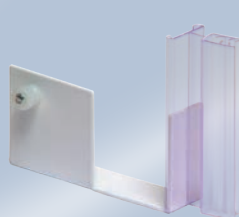

One-Bolt Shelf Break Bracket
PS-USBB-FLX3-W

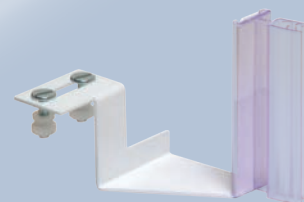

Off-Set Shelf Break Bracket
PP-BB-USB6-W



Slip On Non-Flexible Sign Grips



Holds up to 1/8"
PS-SGS



Holds up to 1/4"
PS-SGSL

Slip On Flexible Sign Grips



Holds up to 1/8"
PS-SGSF



Holds up to 1/4"
PS-SGSFL

Wall Sign Holders

NEW

IN THE AIR
Wall and Shelf Sign Holders



- Help customers navigate through your store by emphasizing categories within departments.
- Highlight brands to increase brand sales.
- Telescoping arms adjusts in 2" increments for versatile placement in pegged areas.
- Custom design, printing and kit packing.

Color Code **I** **W** **G** **B**

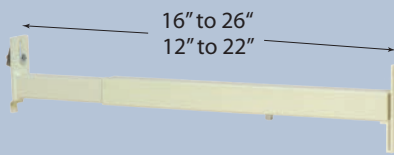

Adj. 1" PowerArm Single Slot w/Locknut
PP-1626SS-FFSL+(color)
PP-1222SS-FFSL+(color)

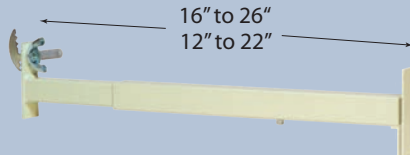

Adj. 1" PowerArm Single Slot w/DSU hwde.
PP-1626DSU-FFSL+(color)
PP-1222DSU-FFSL+(color)

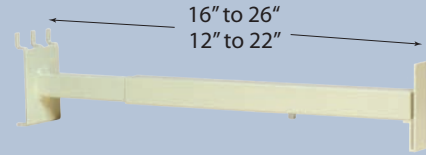

Adj. 1" PowerArm Pegboard
PP-1626PB-FFSL+(color)
PP-1222PB-FFSL+(color)

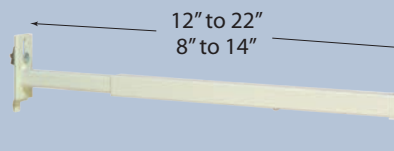

Adj. 3/4" PowerArm Single Slot w/Locknut
PP-1222SS-34FFSL+(color)
PP-814SS-34FFSL+(color)

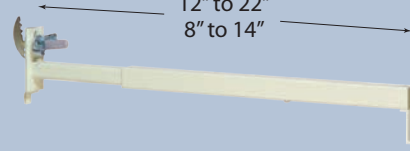

Adj. 3/4" PowerArm Single Slot w/DSU hwde.
PP-1222DSU-34FFSL+(color)
PP-814DSU-34FFSL+(color)

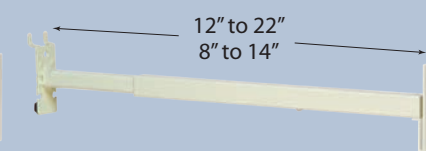

Adj. 3/4" PowerArm Pegboard
PP-1222PB-34FFSL+(color)
PP-814PB-34FFSL+(color)

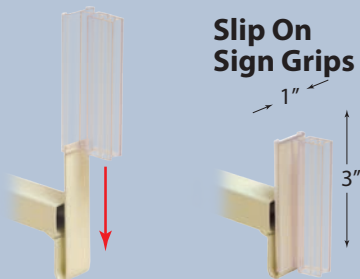

Slip On Sign Grips

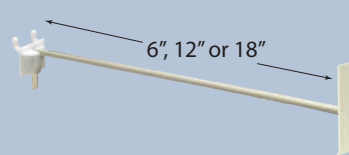

Wire PowerArm Pegboard
PP-12FFPB+(color)
PP-16FFPB+(color)
PP-18FFPB+(color)

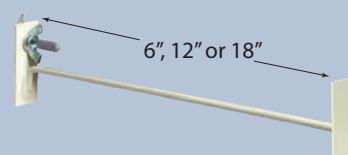

Wire PowerArm Single Slot w/DSU hwde.
PP-6FFDSU+(color)
PP-12FFDSU+(color)
PP-18FFDSU+(color)

800.992.5233 • email: hq@tmshea.com

MagnaGrip & MagnaBrackets



1" Non-Flexible MagnaGrip Perpendicular
PS-SG1MAG
Holds up to 1/8" Material



1" Flexible MagnaGrip
PS-SG1FMAG
Holds up to 1/8" Material



1" MagnaGrip Parallel
PS-SG2MAG
Holds up to 1/8" Material



3" Non-Flexible MagnaGrip .125"
PS-SG3MAG
Holds up to 1/8" Material



3" Flexible MagnaGrip .125"
PS-SGFMAG
Holds up to 1/8" Material



3" Flexible Side Mount MagnaGrip .125"
PS-SG7FMAG
Holds up to 1/8" Material



3" Non-Flexible MagnaGrip .25"
PS-SG6MAG
Holds up to 1/4" Material



3" Flexible MagnaGrip .25"
PS-SGFLMAG
Holds up to 1/4" Material



3" Flexible Side Mount MagnaGrip .25"
PS-SG8FMAG
Holds up to 1/4" Material



3" MagnaBracket with 1 Rivet hole
PS-3LMAG1



3" MagnaBracket with 2 Rivet holes
PS-3LMAG2



3" Channel Magnet
PS-MAGNET3



3" Channel Magnet with Adhesive
PS-MAGNET3-ADH

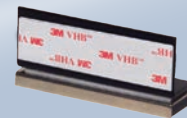

3" MagnaBracket with adhesive
PS-3LMAG



1" Channel Magnet
PS-MAGNET4



1" Channel Magnet with Adhesive
PS-MAGNET4-ADH

Glass Door Suction Signs

8" x 8" x 8" Category Sign with Brand Logo



Glass Bracket Category Sign



Highlight Cooler Areas & Increase Brand Awareness

- Great for brand marketing / advertising promotional messaging.
- Ideal for use on cooler doors.
- Signs change out quickly.
- Custom printing and kit pack outs available.
- 2 Suction cup mounts



8" x 8" x 8" Category sign
Brand sign mounts
above or below



8" x 3" x 8"
Suction Glass Category Signs
Custom Made to Order

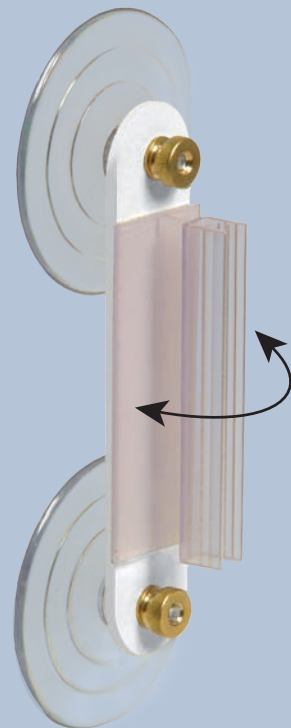

3" Flex Glass Bracket
GB-35SS-I

Category ArcArms™ Double Hook



Color Code **I** **W** **G** **B**
 Custom Colors Available

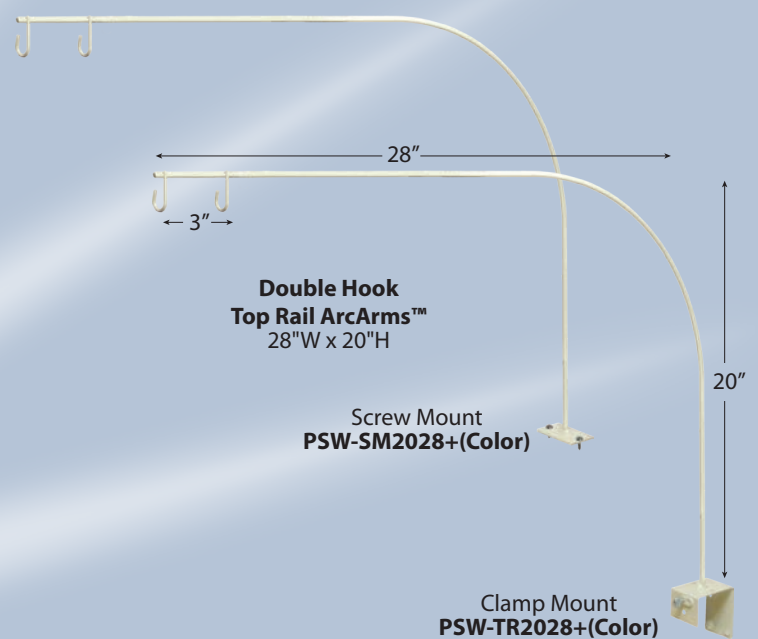
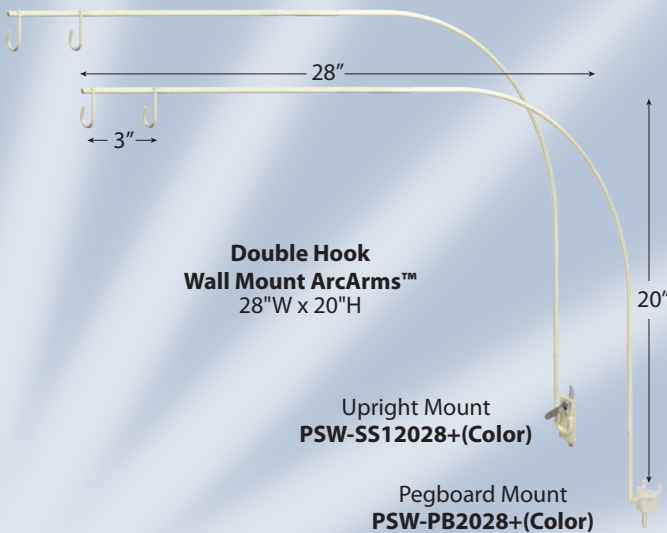
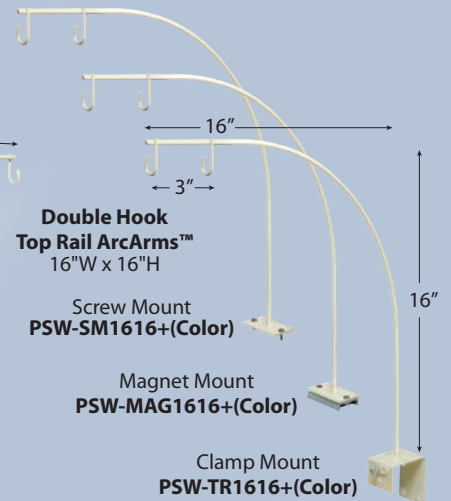
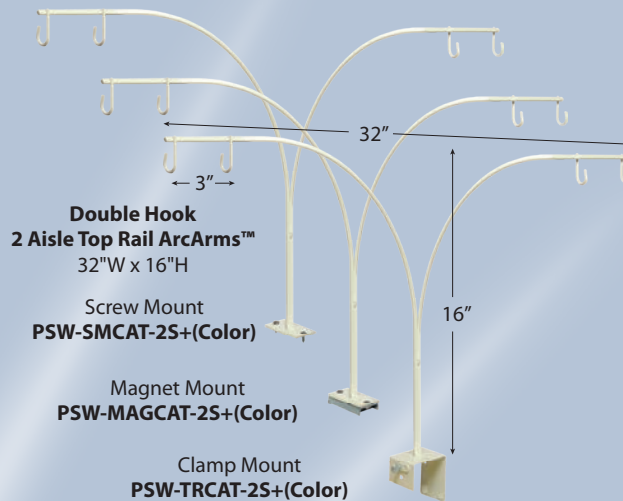
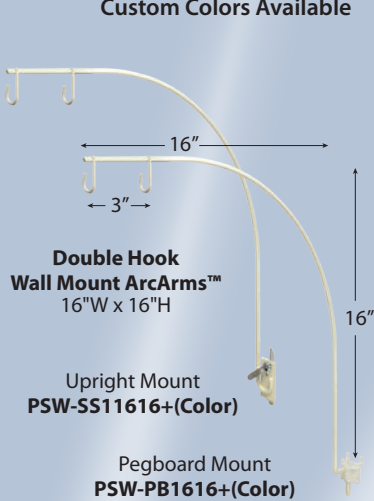



Call Out Categories or Create Brand Awareness

- Help customers navigate through your store by emphasizing categories within departments.
- Highlight brands to increase brand sales.
- Combine with overhead signs to visually enhance a department.
- Custom sizes available

Color Code **I** **W** **G** **B**
Custom Colors Available

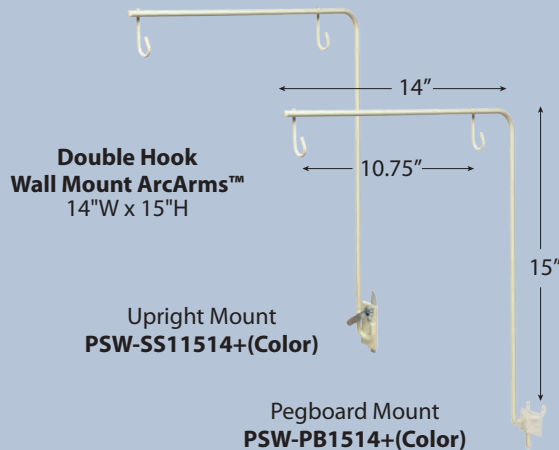
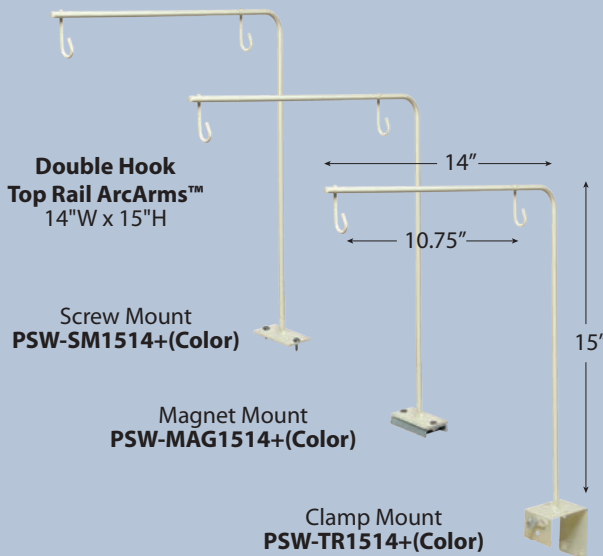
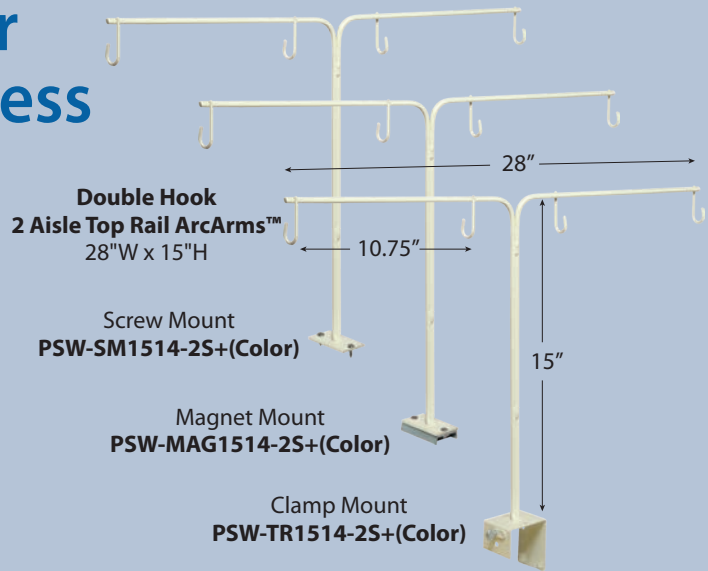

Category ArcArms™ Single Hook

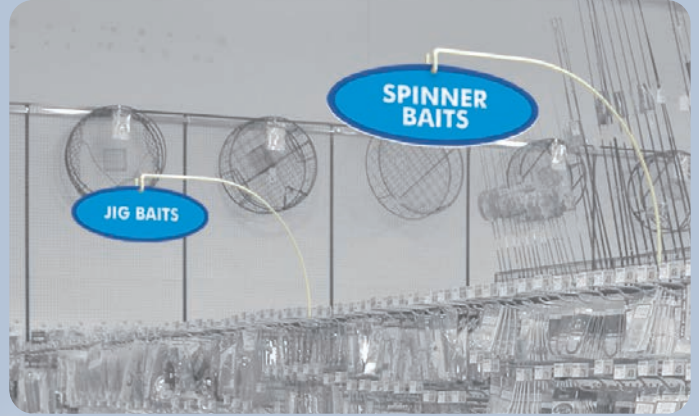

Single Hook Category Signs Will Always Hang Straight!

Color Code **I** **W** **G** **B**
 Custom Colors Available

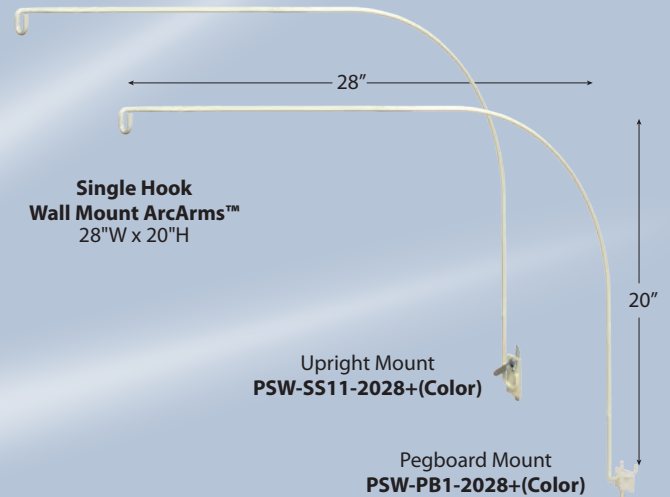
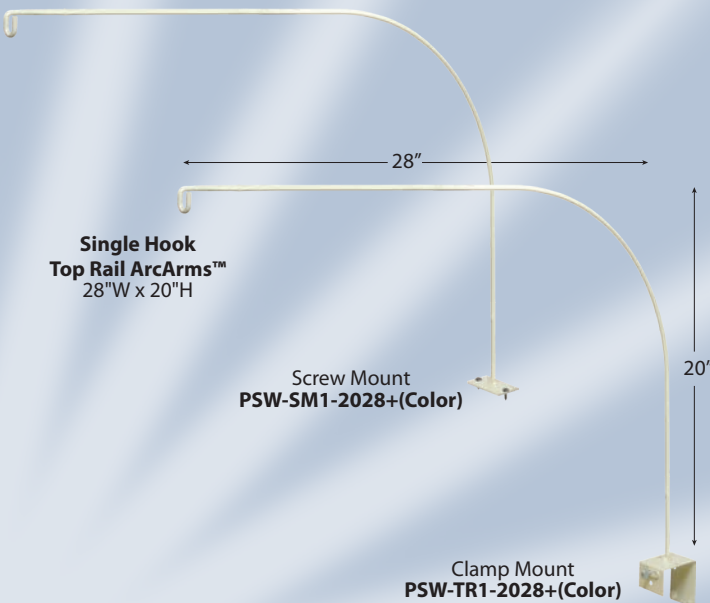
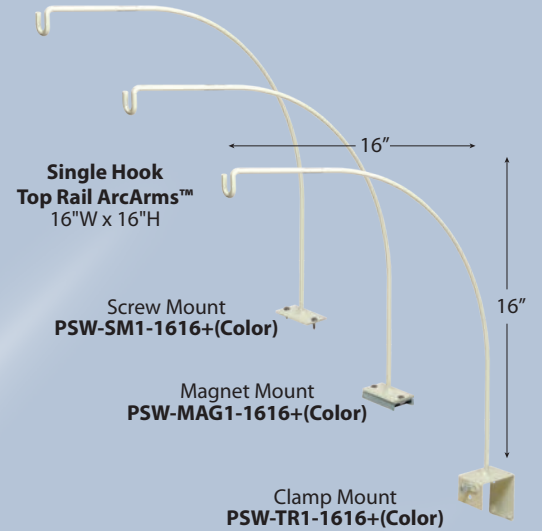
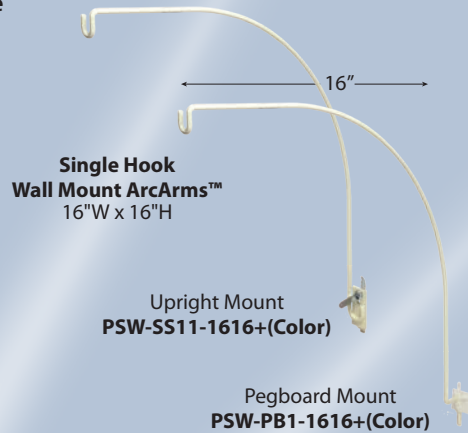



Call Out Categories or Create Brand Awareness

- Help customers navigate through your store by emphasizing categories within departments.
- Highlight brands to increase brand sales.
- Combine with overhead signs to visually enhance a department.
- Custom sizes available

Color Code **I** **W** **G** **B**
Custom Colors Available

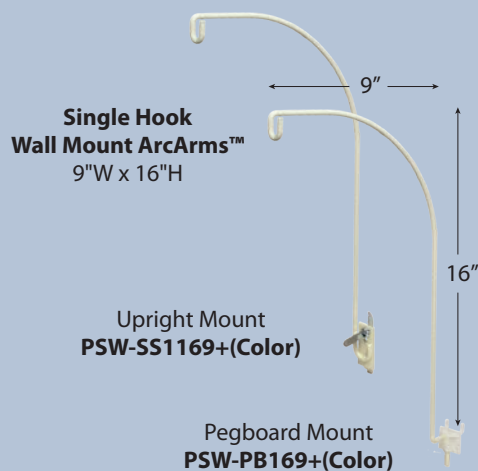
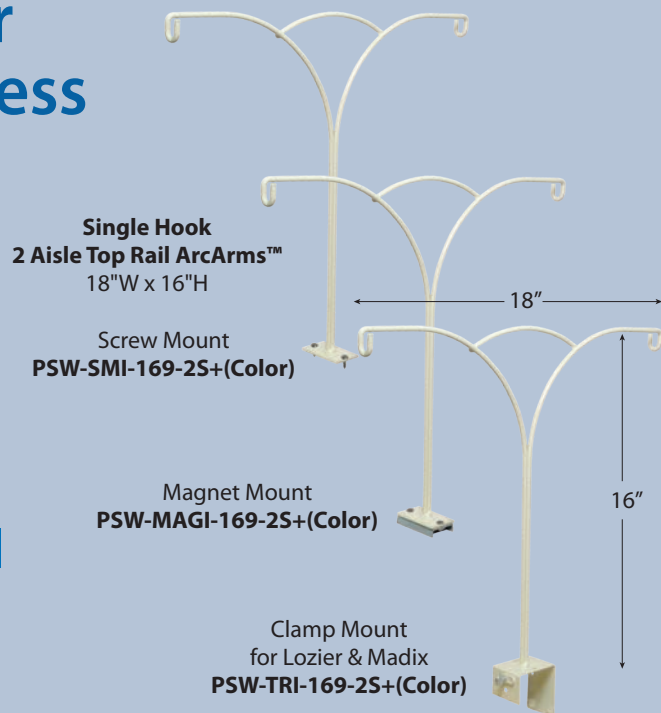
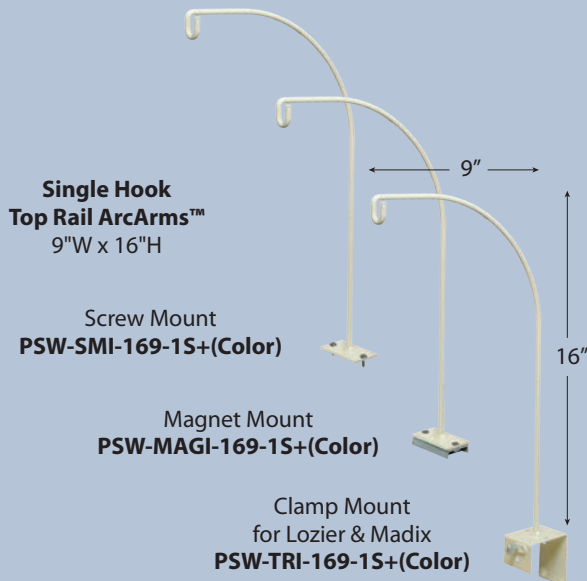

Heavy Duty ArcArms™

Screw Mount Heavy Duty ArcArms™



Wall Mount Heavy Duty ArcArms™

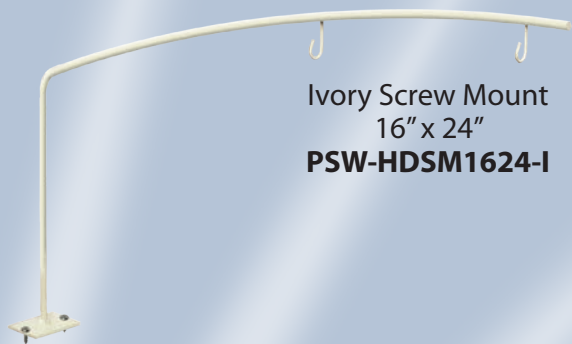
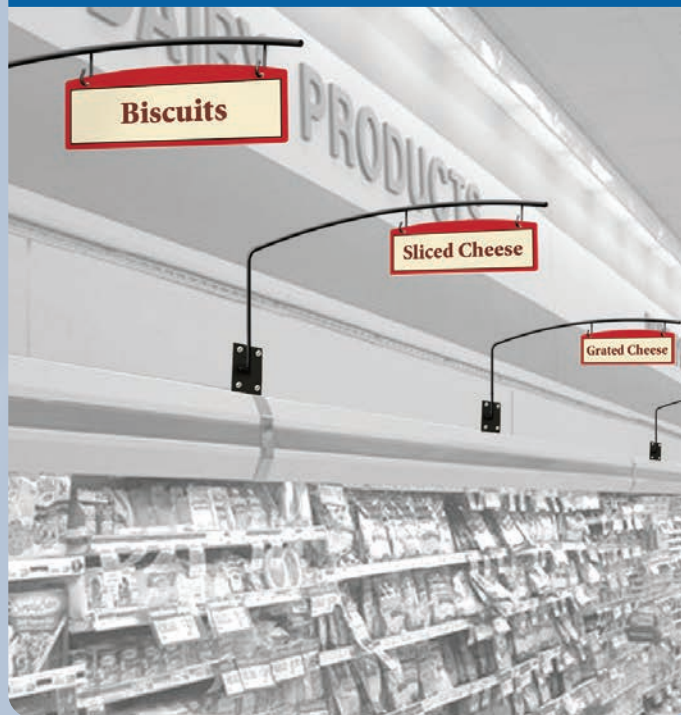

Ivory Screw Mount
16" x 24"
PSW-HDSM1624-I

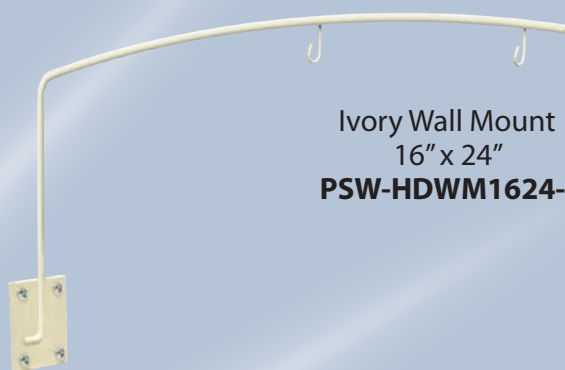

Ivory Wall Mount
16" x 24"
PSW-HDWM1624-I

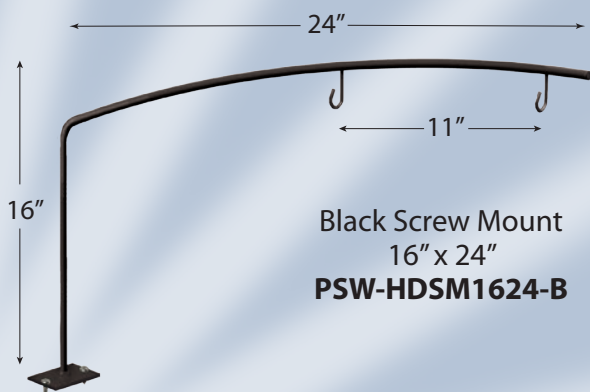

Black Screw Mount
16" x 24"
PSW-HDSM1624-B

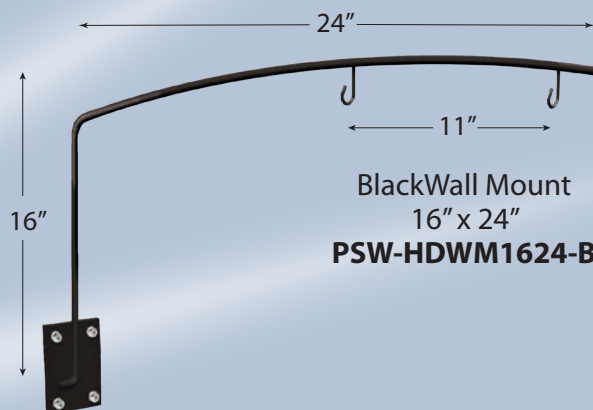

Black Wall Mount
16" x 24"
PSW-HDWM1624-B

Top Rail Heavy Duty ArchArms™



Help Shoppers Navigate Your Store

- Emphasize categories within departments.
- Highlight brands to increase brand sales.
- Combine with overhead signs to visually enhance a department.
- Three mounting options to suspend a variety of sign designs.
- Custom design, printing and kit packing.

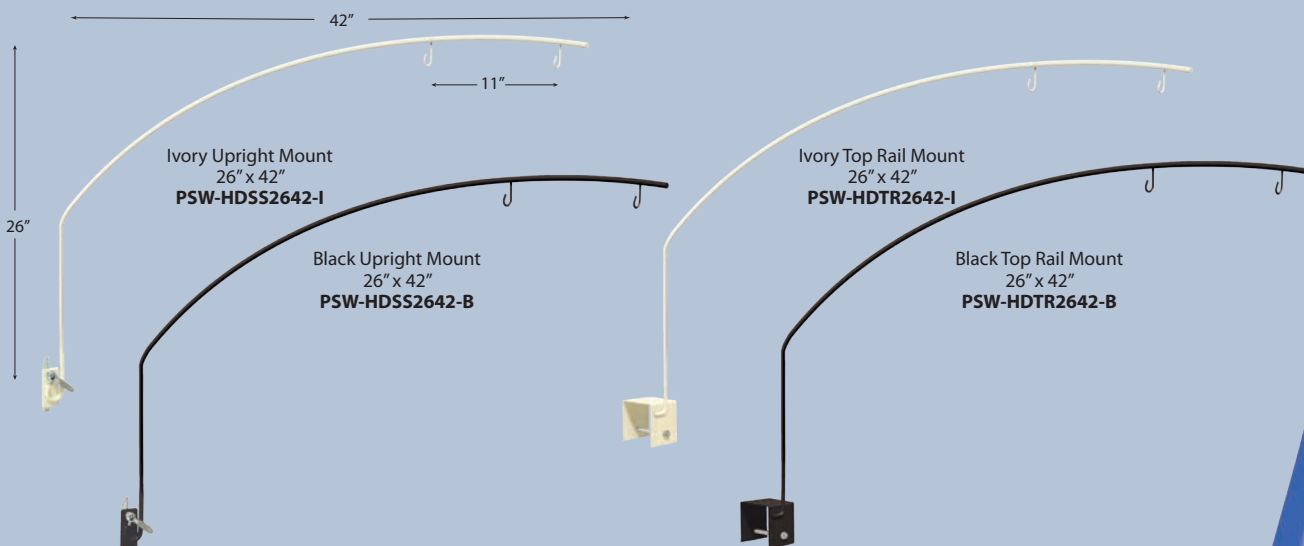

800.992.5233 • email: hq@tmshea.com

Magnetic ArcArms™



- Ideal for promotions and store messaging.
- Magnetic base attaches to any flat metal surface.
- Easy change out for brand promotions and price points.

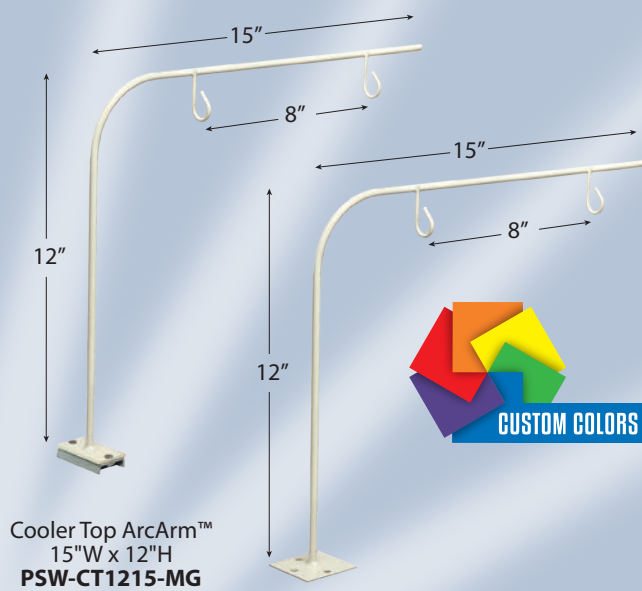

Cooler Top ArcArm™
Mount with 3 Screws
15"W x 12"H
PSW-CT1215-CA

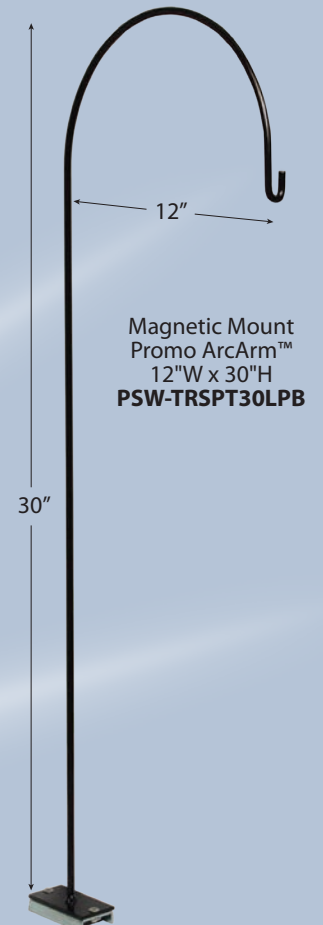
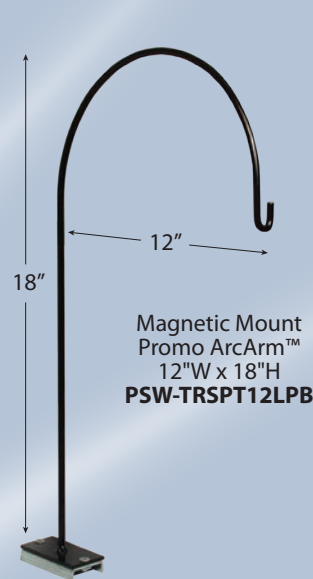

Banner Sign Holders

IN THE AIR
Magnetic ArcArms™ / Banner Sign Holders

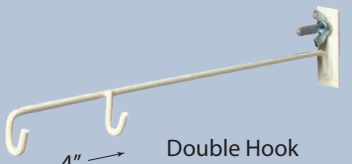

Double Hook
Metal Back Plate Mount
13" – PSW-13+(Back Plate #)
16" – PSW-16+(Back Plate #)
19" – PSW-19+(Back Plate #)



Double Hook
Plastic Pegboard Mount
13" – PSW-13PB-2-B
16" – PSW-16PB-2-B
19" – PSW-19PB-2-B



Single Hook
Plastic Pegboard Mount
13" – PSW-13PB-2-B
16" – PSW-16PB-2-B
19" – PSW-19PB-2-B

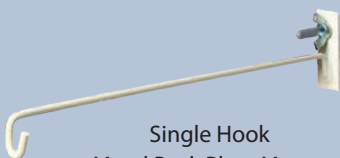

Single Hook
Metal Back Plate Mount
13" – PSW-13+(Back Plate #)
16" – PSW-16+(Back Plate #)
19" – PSW-19+(Back Plate #)

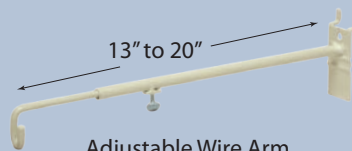

Adjustable Wire Arm
PSW-A1-1320-PB



Adjustable Wire Arm
PSW-A1-1320-DSU1

Add Back Plate Code to Part Number

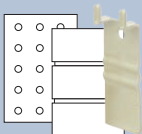

Pegboard
and 3" Slat Wall
PB

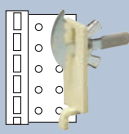

Single Slotted
Upright
SS1

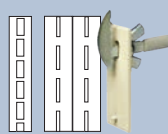

Single & Double
Slotted Upright
DSU1

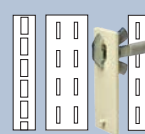

Universal
1-2 Slotted Uprights
DSU2

Create A-Store...

After



Before



After



Before



The above trademarks and those throughout this catalog are owned by the indicated companies and are not owned by T.M. Shea Products, Inc. The trademarks are being used in this catalog only for illustrative purposes and are not intended to indicate any other connection between these companies and T.M. Shea Products, Inc.

Within-A-Store

After

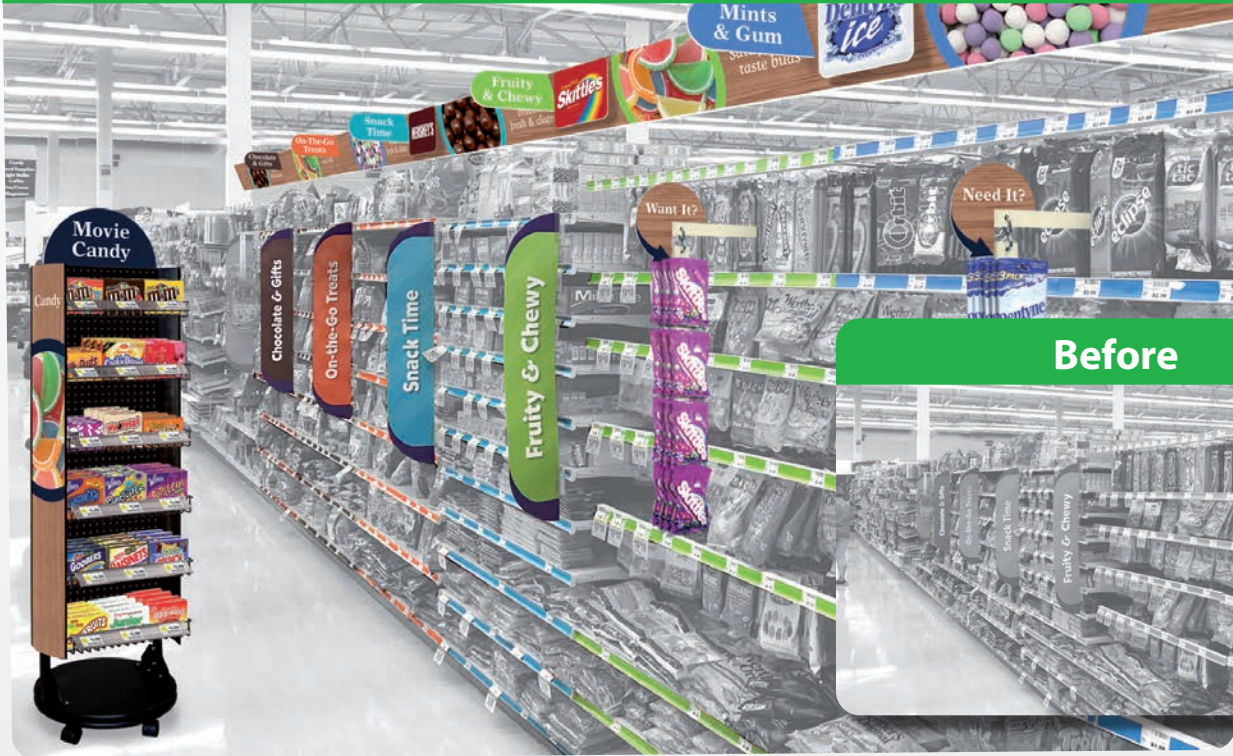

Before



After



Before



Create A-Store...



The above trademarks and those throughout this catalog are owned by the indicated companies and are not owned by T.M. Shea Products, Inc. The trademarks are being used in this catalog only for illustrative purposes and are not intended to indicate any other connection between these companies and T.M. Shea Products, Inc.

Within-A-Store



Some of Our Retail Partners...



1950 Austin Drive • Troy, Michigan 48083-2205
 800-992-5233 • 248-589-3272 • Fax 248-589-1535
 Email: hq@tmshea.com • www.tmshea.com

Intellectual Property of T.M. Shea Products. All rights reserved. © 2020. Warning: The material on these pages are proprietary and shall remain exclusive intellectual property of T.M. Shea Products, Inc. Under no circumstances are any P.O.P. display producers, suppliers, designers, brokers, or employees of such a trade company permitted to utilize this material in any way, shape, or form without the expressed written consent of T.M. Shea Products. Violators will be prosecuted to the fullest extent of the law. The above trademarks and those throughout this catalog are owned by the indicated companies and are not owned by T.M. Shea Products, Inc. The trademarks are being used in this catalog only for illustrative purposes and are not intended to indicate any other connection between these companies and T.M. Shea Products, Inc.



TMSHEA PRODUCTS
IDEAS FOR SPACE IDEAS FOR SALES



IN THE AIR



OFF THE GONDOLA



ON THE FLOOR

3D
**In-Store
Marketing &
Merchandising
Solutions**
Supplement

Suspended Monster PowerPanels

Pegboard and Frames



Includes 2 -15" PowerArms®
with Mounting Hardware

18"W x 48"H
Pegboard & Frame
MPPS-1848-B

18"W x 60"H
Pegboard & Frame
MPPS-1860-B

Includes 2 -21" PowerArms®
with Mounting Hardware

24"W x 60"H
Pegboard & Frame
MPPS-2460-B

Sign Options



Custom Printed Header Sign

- Printed 1 Side on .060" Black Styrene
- Includes 2 Sign Grips
- 8"x 18" Custom Header
- 8"x 24" Custom Header



Plastic Header Sign Channels

- Includes mounting hardware
- 8"x 18" Header Sign Channel
MPP-1808-B
- 8"x 24" Header Sign Channel
MPP-2408-B

Plastic Side Sign Channels

- Includes mounting hardware
- 8"x 48" Side Sign Channels
MPP-0848EXT-B
- 8"x 60" Side Sign Channels
MPP-0860EXT-B

Metal Side Sign Channels

- Includes mounting hardware
- 8"x 48" Side Sign Channels
MPP-0848M-B
- 8"x 60" Side Sign Channels
MPP-0860M-B

Metal Peg Hooks



- 4" Metal Peg Hook
MPWP-4-B
- 6" Metal Peg Hook
MPWP-6-B
- 8" Metal Peg Hook
MPWP-8-B



- 4" Metal Peg Hook with Flip Scan
MPWP-4S-B
- 6" Metal Peg Hook with Flip Scan
MPWP-6S-B
- 8" Metal Peg Hook with Flip Scan
MPWP-8S-B

Pegboard Shelves and Wire Baskets

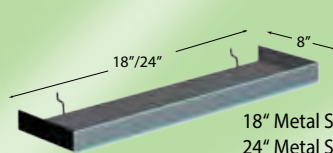

18" Metal Shelf: **MPP-1808-B**
24" Metal Shelf: **MPP-2408-B**

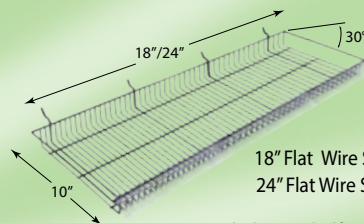

18" Flat Wire Shelf: **WS-1018-ST-B**
24" Flat Wire Shelf: **WS-1024-ST-B**

18" Angled Wire Shelf: **WS-1018-ANG-B**
24" Angled Wire Shelf: **WS-1024-ANG-B**

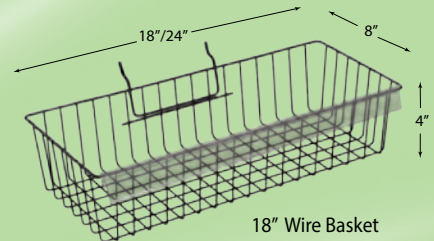

18" Wire Basket
PGB-18X8X4-B
24" Wire Basket
PGB-24X8X4-B



Wire Basket Divider
PGB-8WBD



Our gondola displays are environmentally friendly unlike disposable plastic merchandising strips.



18" Width x 48" Height

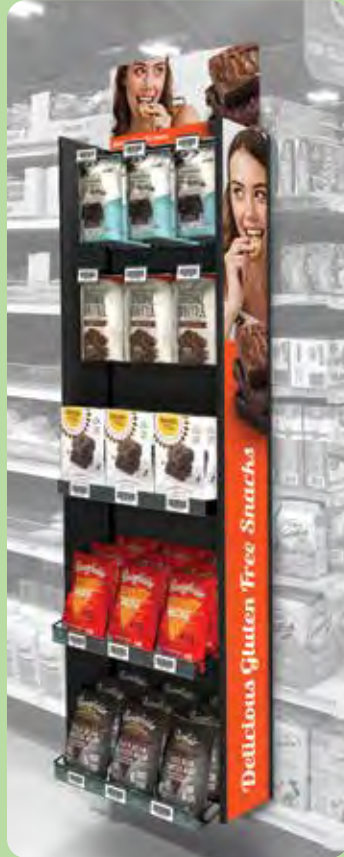

18" Width x 60" Height

Far more selling space than traditional 14"x 48" metal wing racks

- Heavy duty suspension arms
- 3 Sizes to choose from 18"x48"/ 18"x 60"/ 24"x60"
- Variety of peg hooks, shelves, bins and baskets
- Metal or plastic side sign holders
- 18" or 24" x 8" header sign holders or sign grips for custom printed signs



24" Width x 60" Height

800.992.5233 • email: hq@tmshea.com

Fast, Easy Assembly

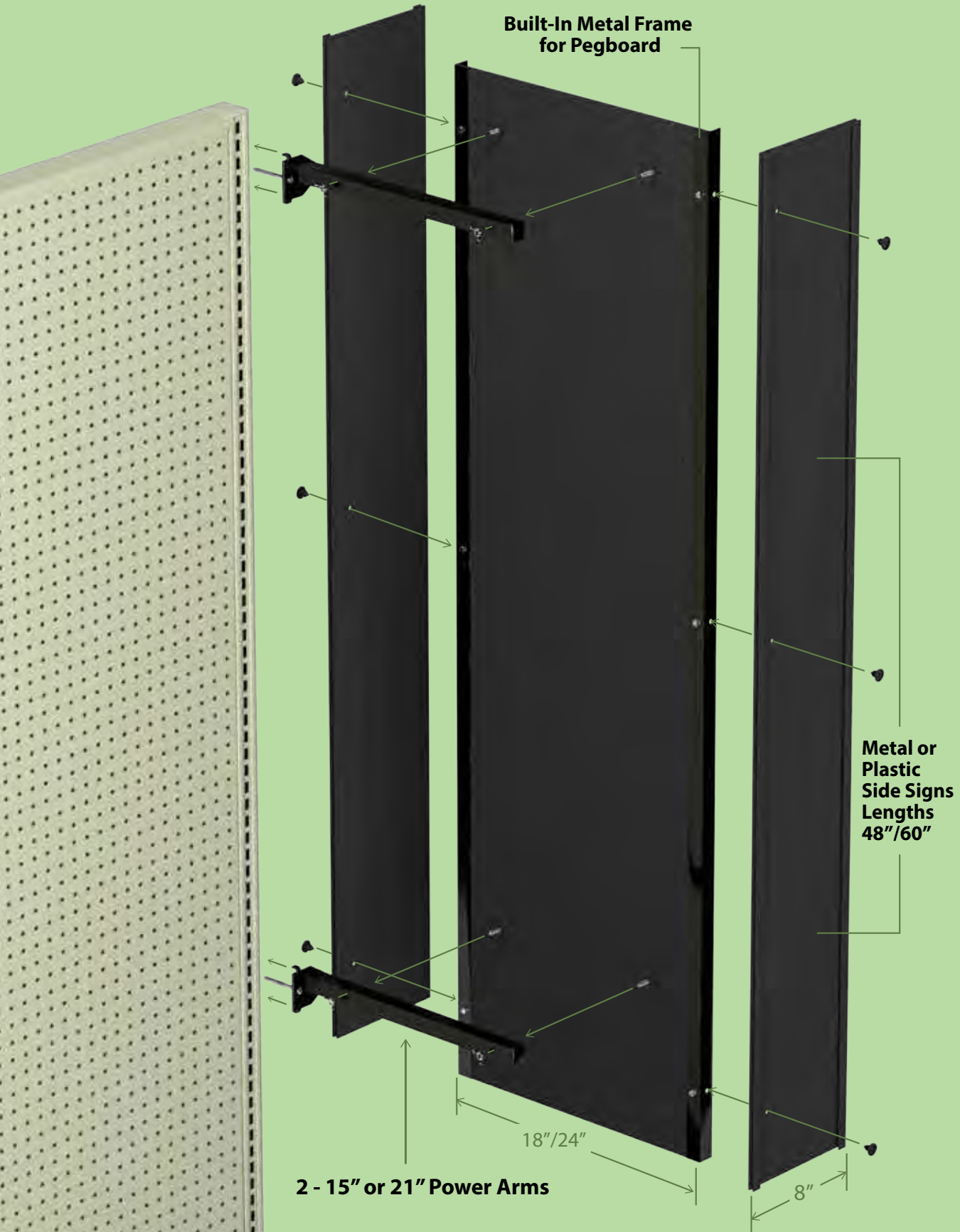

Our gondola displays are environmentally friendly unlike disposable plastic merchandising strips.

Upright Mount Locking Security Case

OFF THE GONDOLA
Upright Mount Locking Security Case

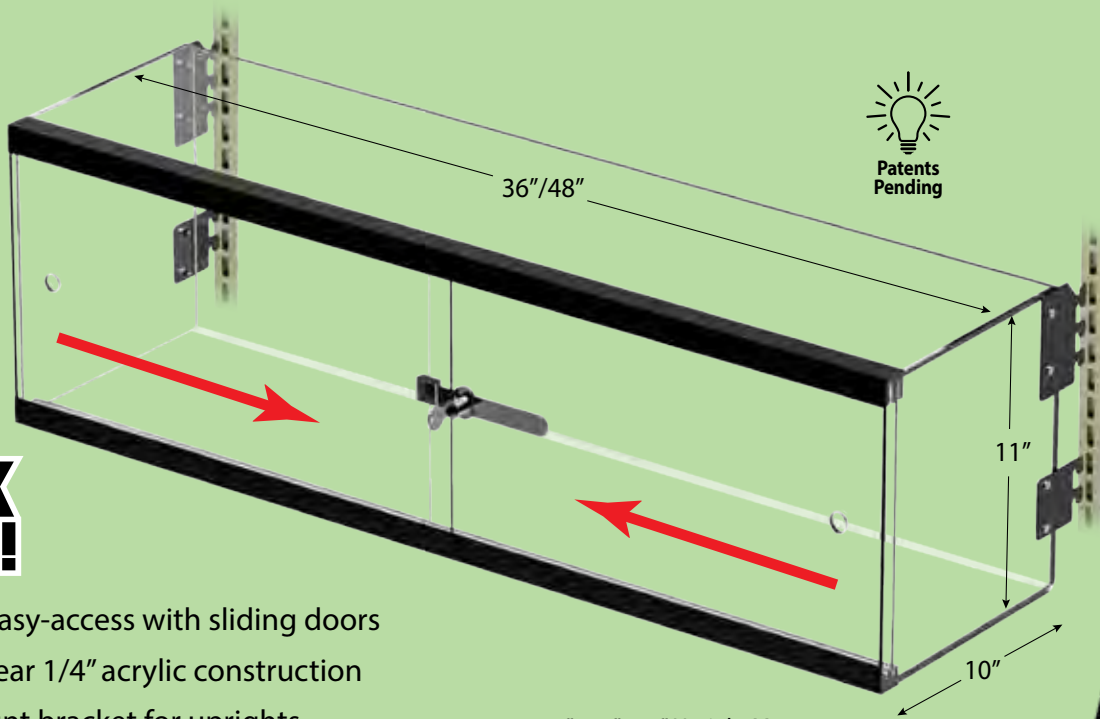

- Key Lock Easy-access with sliding doors
- Durable clear 1/4" acrylic construction
- Metal mount bracket for uprights
- Low profile dividers keeps items organized
- Optional data strips with adhesive for paper UPC labels and printed graphics

36"x 11"x 10" Upright Mount
Locking Security Case
CSC-KPM361210

48"x 11"x 10" Upright Mount
Locking Security Case
CSC-KPM48125

800.992.5233 • email: hq@tmshea.com

SideWinder™ Brackets



White **W** Ivory **I** Grey **Gr** Black **Bk**

PowerStrips™
1.25" Stock Hole Spacing
15" Length **PS-15A+(Color)**
20" Length **PS-20A+(Color)**
30" Length **PS-30A+(Color)**
36" Length **PS-36A+(Color)**
48" Length **PS-48A+(Color)**



PSH-1A
1" Peg Hook

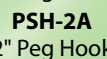

PSH-2A
2" Peg Hook

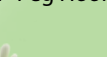

PSH-4A
4" Peg Hook



PSH-2SA
2" Peg Hook with Scan Plate

PSH-4SA
4" Peg Hook with Scan Plate



PSH-2BA
2" Butterfly Peg Hook

PSH-3BA
3" Butterfly Peg Hook

PSH-4BA
4" Butterfly Peg Hook



PSH-2SFA
2" Peg Hook with Flip Scan Plate



PS-SG3
1" Long Sign Grip



2.0"-DATASTRIP2.OFT
Data Strip with Foam Tape Adhesive



PS-CS31MLDH
31" Heavy Duty Clip Strip



Our gondola displays are environmentally friendly unlike disposable plastic merchandising strips.



Create Strong Impulse Sales from Both Directions

- Easy to assemble to end cap side rails
- Universal left side or right side placement
- Standard color is ivory
(MOQ 500 pcs. for custom colors)
- Works on Lozier/Madix Gondola side rails
- SwingStrip® length sizes: 15"/20"/30"/36"/48"

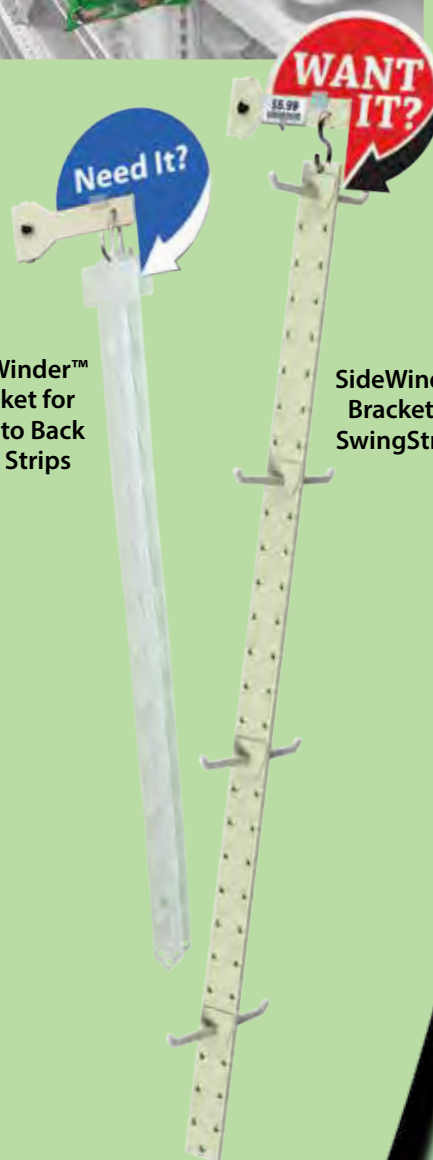

SideWinder™
Bracket for
Back to Back
Clip Strips

SideWinder™
Bracket for
SwingStrips®



Through Bolt
Mounts Bracket
to Side Rails
(cut away view)



Patents
Pending

800.992.5233 • email: hq@tmshea.com

Bunker Grids



Grid Accessories



PG3-6S-B
6" Metal Grid Peg Hook
with Flip Scan

PG3-8S-B
8" Metal Grid Peg Hook
with Flip Scan

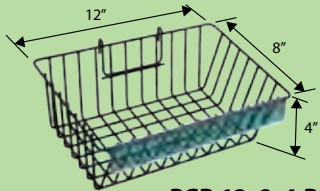

PGB-12x8x4-B
Small 12" x 8" x 4"
Wire Grid Basket

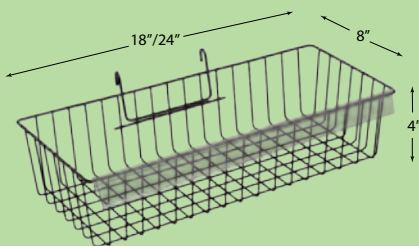

PGB-18x8x4-B
Large 18" x 8" x 4"
Wire Grid Basket

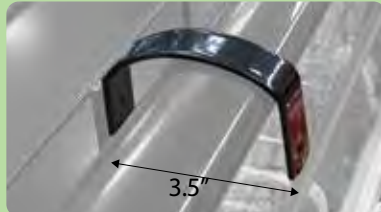

Curved Bracket with Anti Slip Rubber Coating

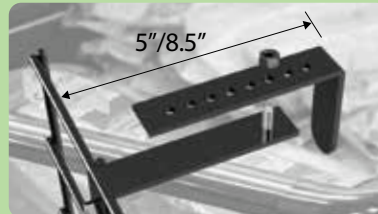

Adjustable Bracket to Fit Railings 5" to 8.5"

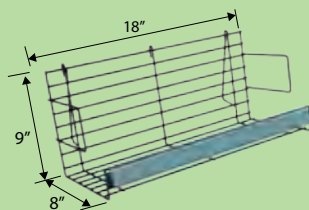

PGB-18x8x9-B
18" x 9" Angled Back Wire Shelf
for Wine (Holds up to 12 Bottles)

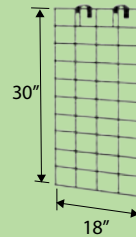

BG-F1830-B
18x30" Bunker Grid with
3" spacing, black, with fixed
3.5" hanging brackets

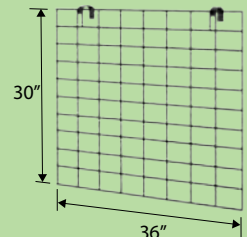

BG-F3630-B
18x36" Bunker Grid with
3" spacing, black, with fixed
3.5" hanging brackets

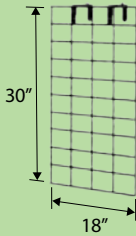

BG-A1830-B
18x30" Bunker Grid with 3"
spacing, black, with adjustable
5-8.5" hanging brackets

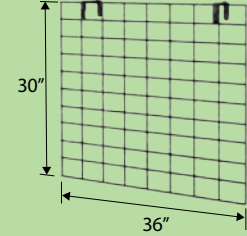

BG-A3630-B
18x36" Bunker Grid with 3"
spacing, black, with adjustable
5-8.5" hanging brackets

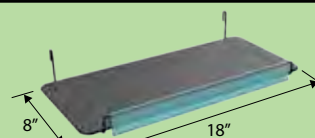

MPPS-1808NS-B
18" x 8" Metal PowerGrid,
No Sides Flat Shelf, Black

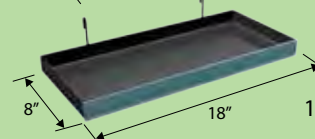

MPPS-1808S-B
18" x 8" Metal PowerGrid,
with Sides, Black

4-Way Cooler Grids



OFF THE GONDOLA
Bunker Grids & 4-Way Cooler Grids

Give your shoppers meal solutions and capture more impulse sales

- Easy install/modular POG options
- Reduce floor display clutter
- Ensure clean floor policy
- Suction mounting in seconds with anti-slip suction cups
- Visually more appealing product displays and easy to clean floors
- Rotate products for seasonality & new product promotions
- Meal pairing tie-in promotions
- Featured new items
- High end condiments
- Quality Private label products
- Wine pairing recommendations

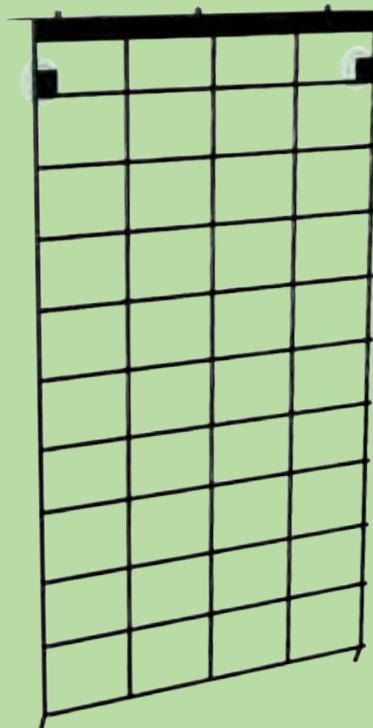

Securely Attaches with 5 Suction Cups



AG-SC1834-B
18" x 34"
4-Way Cooler island
Suction PowerGrid

800.992.5233 • email: hq@tmshea.com



Our gondola displays are environmentally friendly unlike disposable plastic merchandising strips.

Monster PowerPanel Floor Displays

Metal Peg Hooks



4" Metal Peg Hook
MPWP-4-B

6" Metal Peg Hook
MPWP-6-B

8" Metal Peg Hook
MPWP-8-B



4" Metal Peg Hook
with Flip Scan
MPWP-4S-B

6" Metal Peg Hook
with Flip Scan
MPWP-6S-B

8" Metal Peg Hook
with Flip Scan
MPWP-8S-B

Pegboard Shelves and Wire Baskets

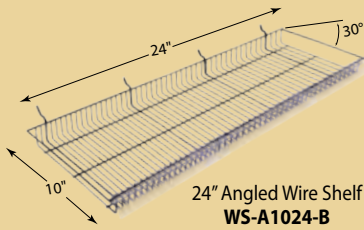

24" Angled Wire Shelf
WS-A1024-B

24" Flat Wire Shelf
WS-1018-B

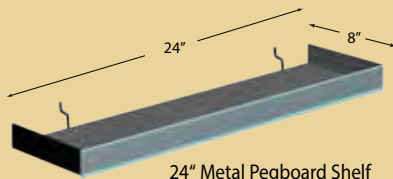

24" Metal Pegboard Shelf
MPPS-2408-B

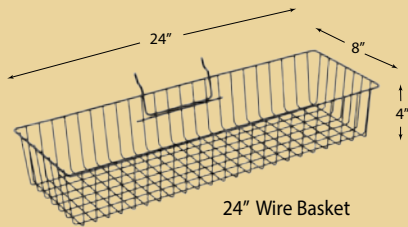

24" Wire Basket
PGB-24X8X4-B



Wire Basket
Divider
PGB-8WBD



Case Stacker Base
MPP-24X12CSB-B



Monster PowerPanel base unit



Monster PowerPanel with custom side signs and custom header

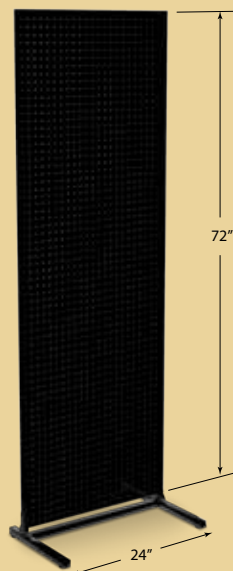

MPPF-2472-B
Monster PowerPanel
24" x 72" Pegboard

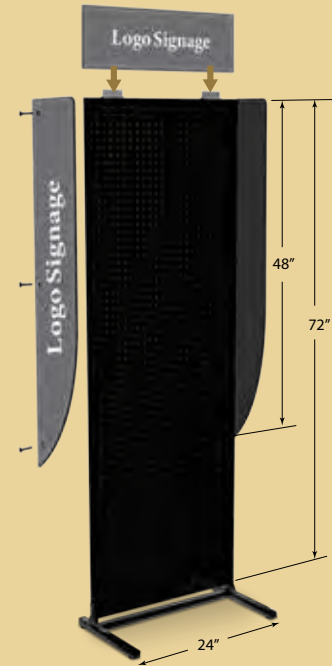

Monster PowerPanel
24" x 72" Pegboard with
8" x 48" Custom Die Cut Signs
24" x 8" Custom Header



Our floor displays are environmentally friendly unlike disposable cardboard floor displays.



Make Your End Cap Sides Work Harder and Smarter for You

- Maximize your selling space and promotions.
- Increase your sales, profits and merchandising flexibility
- Deliver strong promotions by product category, brand, private label, seasonal, and new products.
- Offer both GM/HBC and food solutions with product rotation.
- Flexible POG merchandising with metal peg hooks, shelving and wire dump bins.
- High profile locations for down the aisle and perimeter visibility.



Patents Pending

800.992.5233 • email: hq@tmshea.com

Monster PowerPanel Floor Displays

Header Sign Options



Custom Printed Header Sign
 Printed 1 Side on .060" Black Styrene
 Includes 2 Sign Grips
 8"x 24" Custom Header



Plastic Header Sign Channels
 Includes mounting hardware
 8"x 24" Header Sign Channel
MPP-2408-B

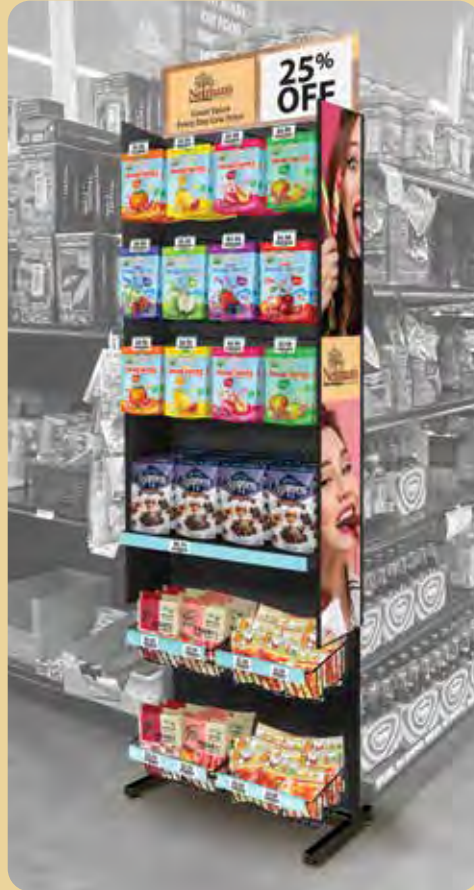

Monster PowerPanel with plastic sign channels, optional custom header and clear sign sleeve



Monster PowerPanel with metal sign channels, and 24"x 8" optional metal sign channel header

Easy Assembly

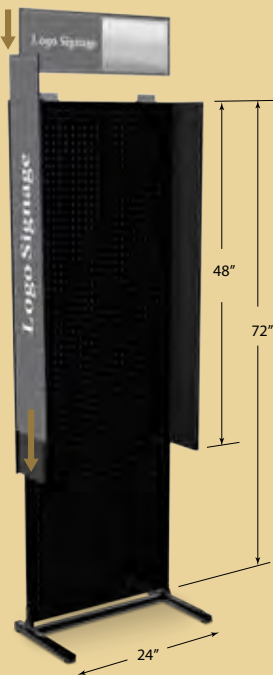
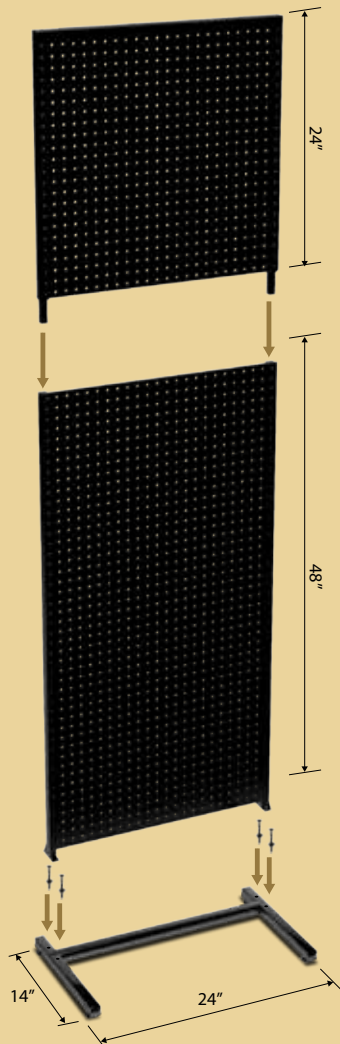

Monster PowerPanel
 24" x 72" Pegboard with
 8" x 48" Plastic Sign Channels
 Optional Custom Header and Clear Sign Sleeve

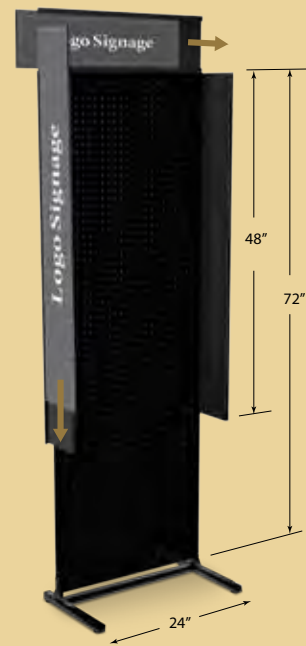

Monster PowerPanel
 24" x 72" Pegboard with
 8" x 48" Metal Sign Channels
 Optional Metal Sign Channel Header

Top Rail Metal Frame



Ideal for end cap promotions

- Quick easy sign change out
- Holds signs printed 2-sided or 1-sided with spacers
- Durable metal construction
- Self-tapping sheet metal screw mount

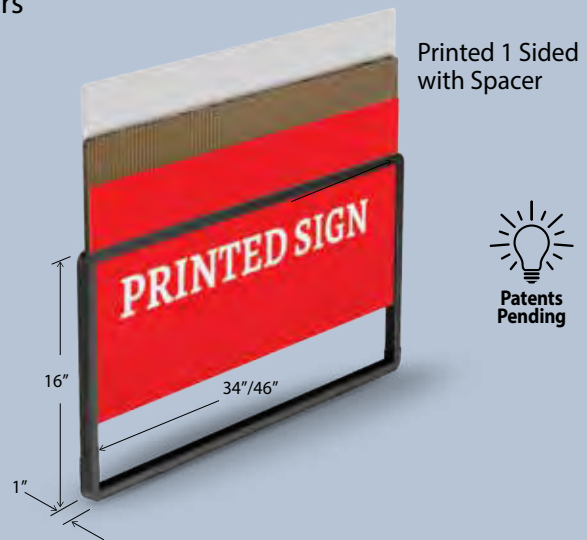
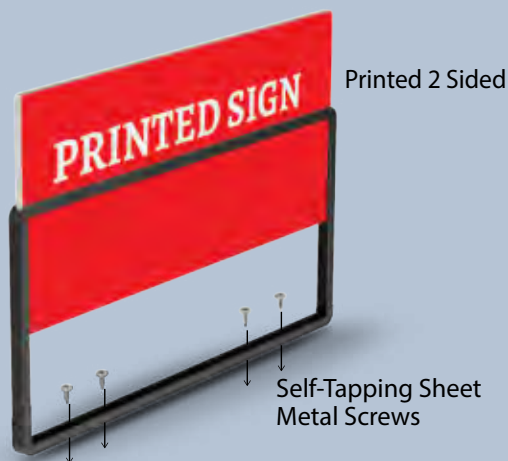

Screw Mount Sign Frames
1" x 34": # ECSF-SM0134-B
1" x 46": # ECSF-SM0146-B

Shelf Edge Overhead Lifestyle/Wayfinding Sign System



Flexible Sign Grips hold category signs between graphic panels



Easily change out graphics and pop-out signs on plastic sign channels

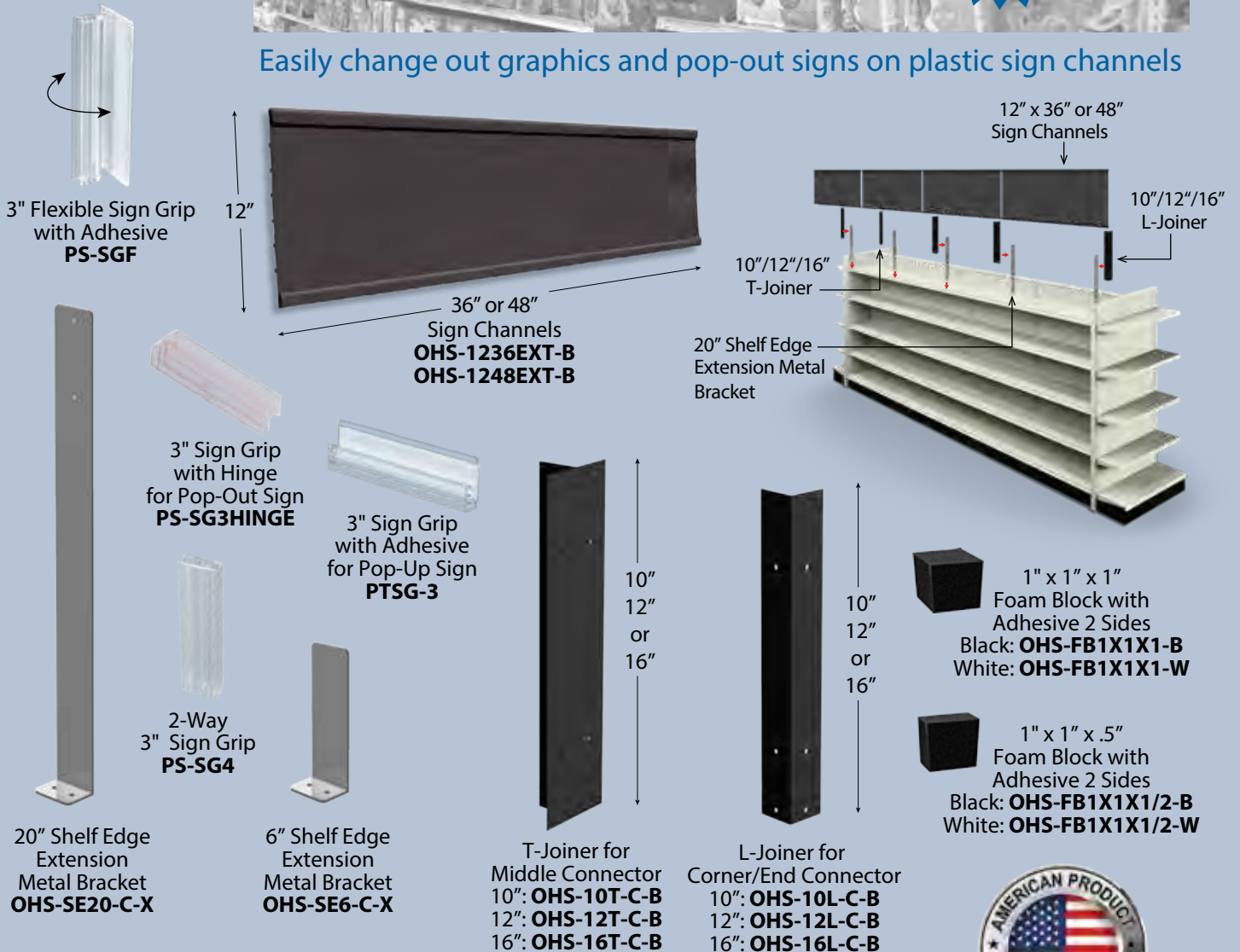

 Our gondola displays are environmentally friendly unlike disposable plastic merchandising strips.



Shelf Edge Wayfinding Sign System



Patents Pending

Increase traffic and guide shoppers down the aisles with Shelf Edge Category Signs

Top shelf category signs down aisle



Category signs and sub category signs



Custom Printed Direct on Rigid Substrates

Call us for details!

Enhance the shopping experience!
Combine lifestyle and promotional graphics with category signs

800.992.5233 • email: hq@tmshea.com

Other Great In-Store Marketing and Merchandising Solutions

Patented & Patent Pending Designs

OFF THE GONDOLA



ON THE FLOOR



IN THE AIR



1950 Austin Drive • Troy, Michigan 48083-2205
 800-992-5233 • 248-589-3272 • Fax 248-589-1535
 Email: hq@tmshea.com • www.tmshea.com

Intellectual Property of T.M. Shea Products. All rights reserved. © 2022. Warning: The material on these pages are proprietary and shall remain exclusive intellectual property of T.M. Shea Products, Inc. Under no circumstances are any P.O.P. display producers, suppliers, designers, brokers, or employees of such a trade company permitted to utilize this material in any way, shape, or form without the expressed written consent of T.M. Shea Products. Violators will be prosecuted to the fullest extent of the law. The above trademarks and those throughout this catalog are owned by the indicated companies and are not owned by T.M. Shea Products, Inc. The trademarks are being used in this catalog only for illustrative purposes and are not intended to indicate any other connection between these companies and T.M. Shea Products, Inc.

NEW

for Winter
22/23!

IN THE AIR

OFF THE GONDOLA

Gift
Cards

ON THE FLOOR



3D
In-Store
Marketing &
Merchandising
Solutions
Supplement

Metal PegStrips

2 Sided Swinging Displays

OFF THE GONDOLA
Metal 2 Sided Swinging PegStrips



Shelf

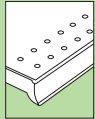

Metal Under Shelf Bracket for Standard Shelves, Black PS-USB5-B



Upright

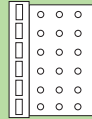

12"-22" Adjustable PowerArm®, Black PS-1222DSU1-B

NEW

Custom Sizes, Peg Hooks, Frequency and Colors

Made to Order

Color Code **I** **W** **G**

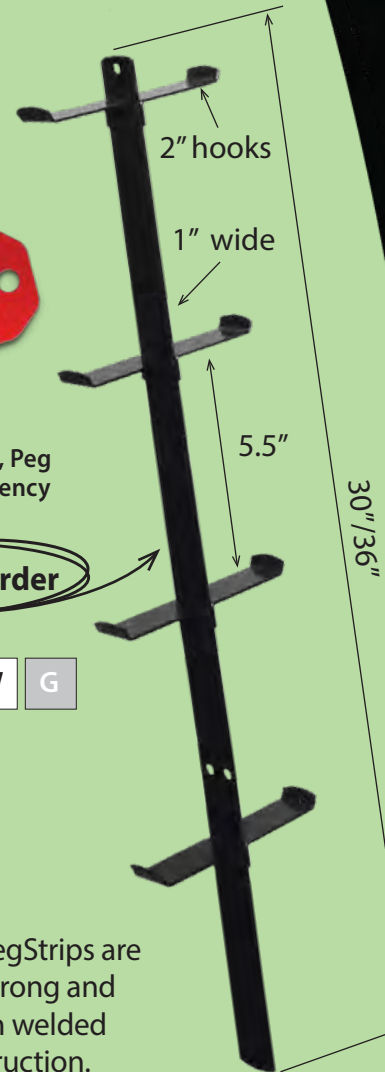

Pallet/Hyper Max

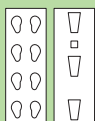

Pallet Rack Bracket, Black PR-1-B



Upright

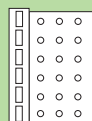

Fixed PowerBar™, Black PS-16FDSU1-B

- The metal PegStrips are extremely strong and durable with welded metal construction.
- Two sided version has 2 inch peg hooks the one sided version has 3 inch peg hooks.
- Metal PegStrips can be positioned in a multitude of locations in the store.
- Mounts with shelf brackets, wall brackets or pallet brackets.
- Product can be preloaded or just packed into the box for loading at store.
- Standard color is black but can be custom made with any color and size needed.
- Designed to capture unused air space and deliver new impulse sales.

Metal PegStrips

1 Sided Displays

OFF THE GONDOLA
Metal 1 Sided PegStrips

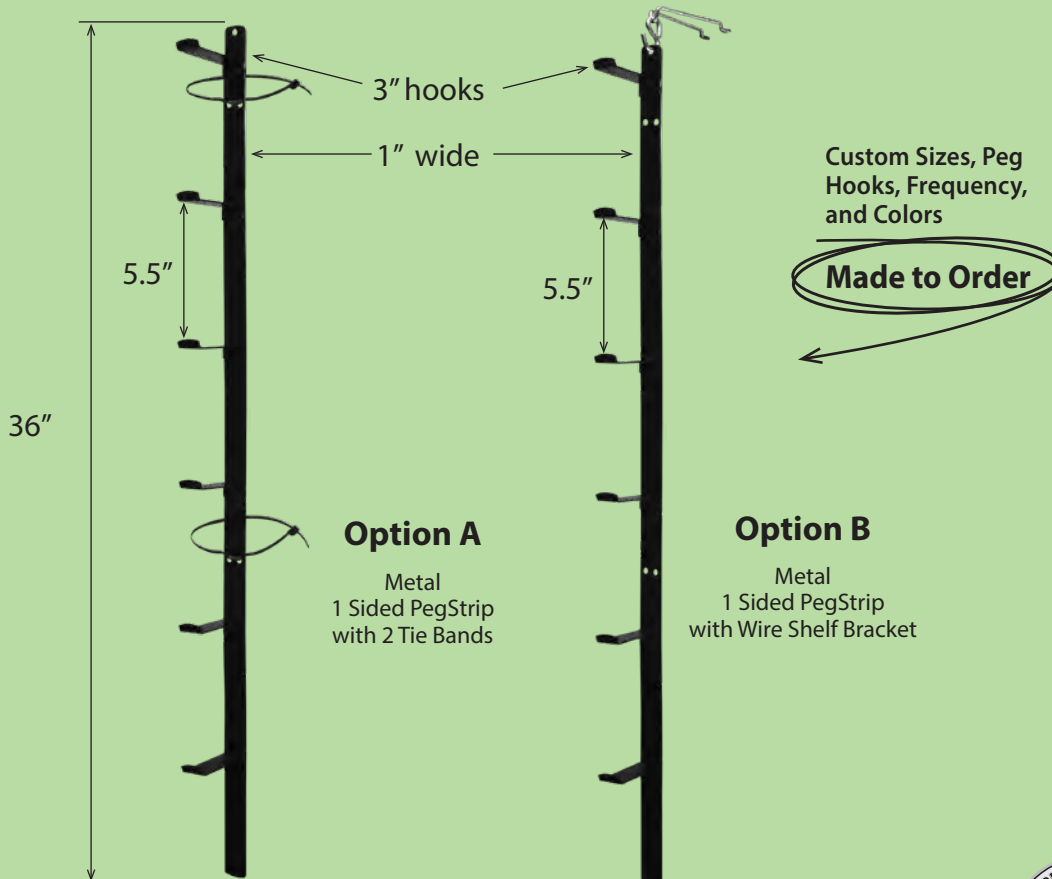

Beverage Cooler Side Wire Shelf Display

OFF THE GONDOLA
Beverage Cooler Side Wire Shelf Display

NEW

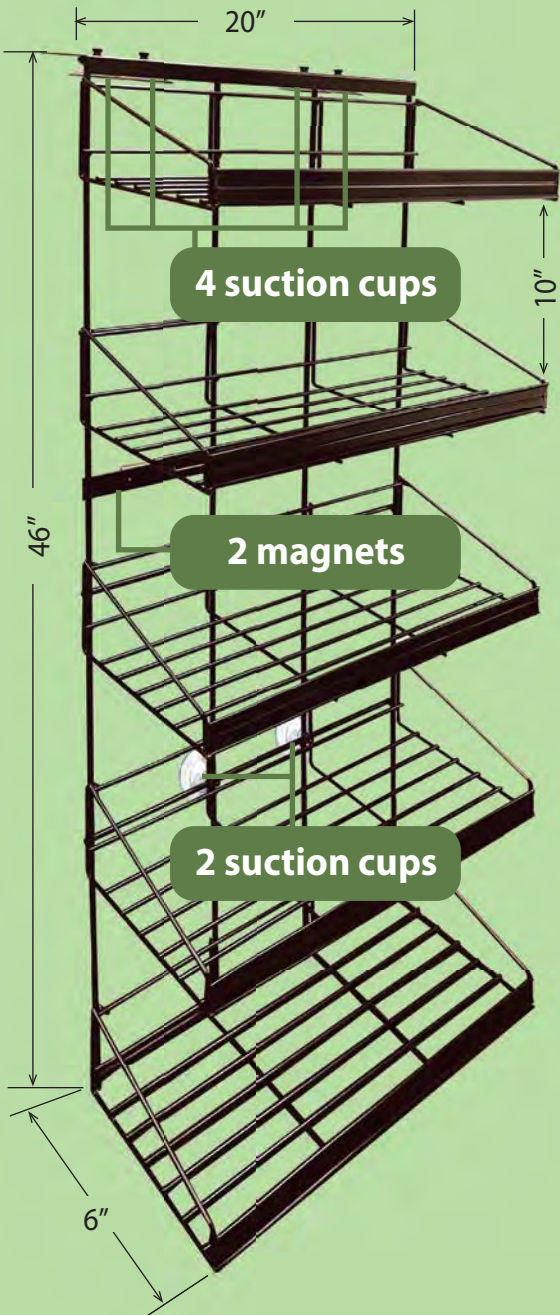

Beverage Cooler Side
5 Shelf Wire Display

With Casters
BC-2046-5-B



Create new space for impulse sales on the side of coolers

- Great for food or beverage impulse sales.
- 5 fixed wire shelves (10" spacing between shelves).
- Metal shelf edge channel for branded printed strips and UPC labels.
- Installs in seconds.
- Easy to shop and reload.



Patents
Pending



800.992.5233
email: hq@tmshea.com
www.tmshea.com



Endcap Side Panel Grid Display

OFF THE GONDOLA
Endcap Side Panel Grid Display

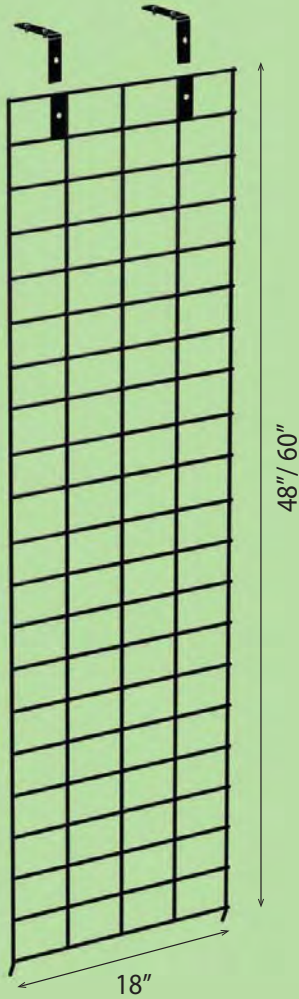

4" Metal peg hooks with flip scan: **PG3-4S-B**

6" Metal peg hooks with flip scan: **PG3-6S-B**

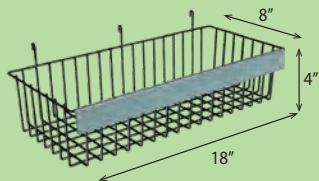

18" Flat wire shelf: **WS-1808-B**
18" Angled wire shelf: **WS-A1808-B**

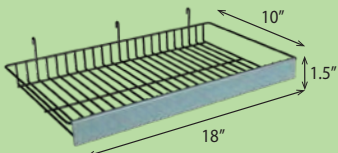

18" Flat wire shelf: **WS-1810-B**
18" Angled wire shelf: **WS-A1810-B**

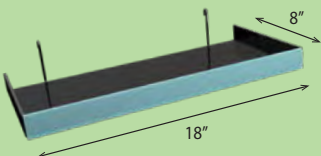

NEW

Bracket Mounting Options



Hook Over Bracket

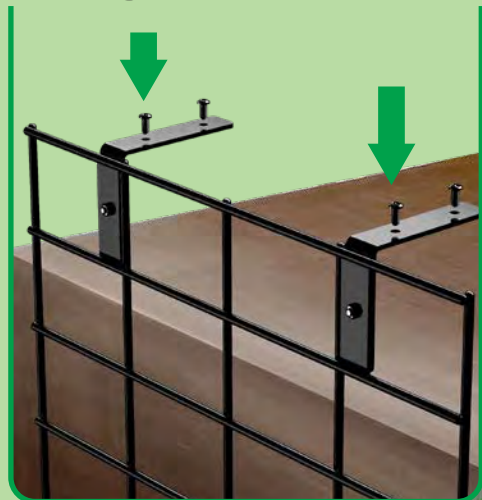

Top Mount L Bracket

800.992.5233 • email: hq@tmshea.com

1 & 2 Sided PowerGrids™

ON THE FLOOR
1 & 2 Sided PowerGrids™



Side of End Caps: 32"x 60" 1 Sided



Perimeter & Checkout area: 18"x 60" 2 Sided

NEW SIZES
18" x 60" • 32" x 60"

Create new shopper solution centers for impulse sales throughout your store

- Our 3" wire PowerGrid offers two new display sizes to choose from; 18"x 60" and 32"x 60".
- Current PowerGrid sizes are 14" x 48" and 18" x 54".
- This PowerGrid enables you to transform the display from a 2-sided merchandising center, to a 1-sided display that can be placed on the side of end caps against walls and anywhere on the floor at the checkout area and perimeter aisles.
- The PowerGrids can ship fully assembled or unassembled. These displays are versatile and extremely durable.
- Ideal for cross merchandising private labels, national brands, food and non-food products.
- Header and side signs can be easily changed out.

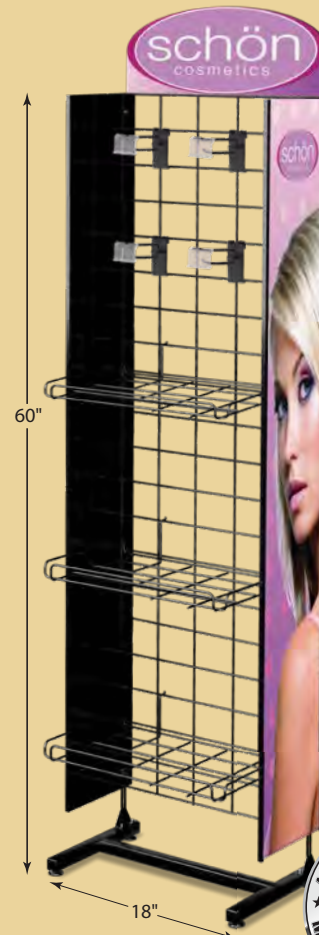



Patents Pending



1 & 2 Sided PowerGrids™

ON THE FLOOR
1 & 2 Sided PowerGrids™

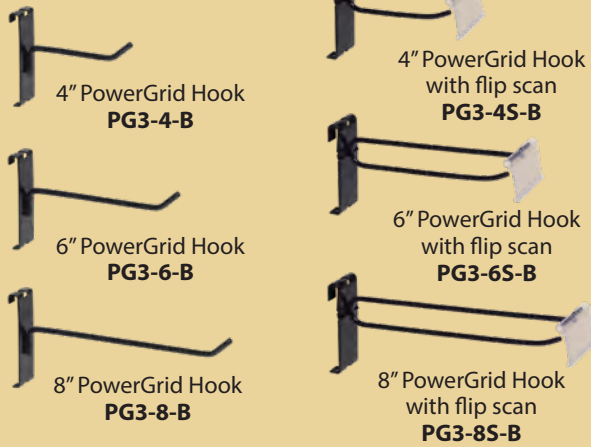
PowerGrid Hooks



Wire Shelves

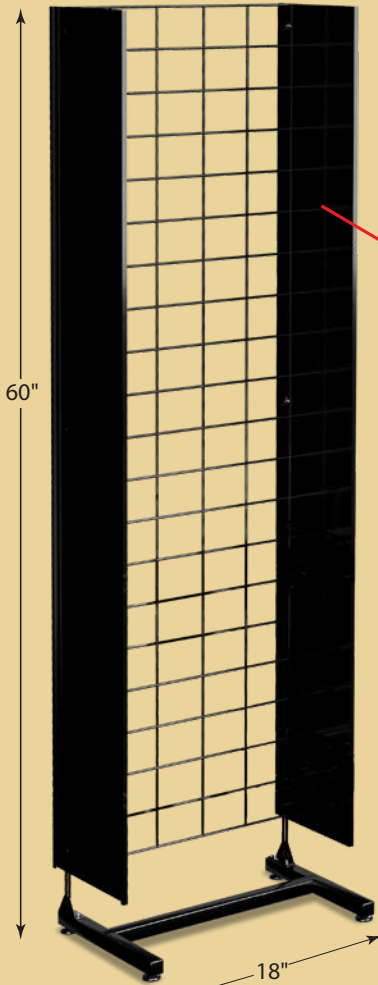
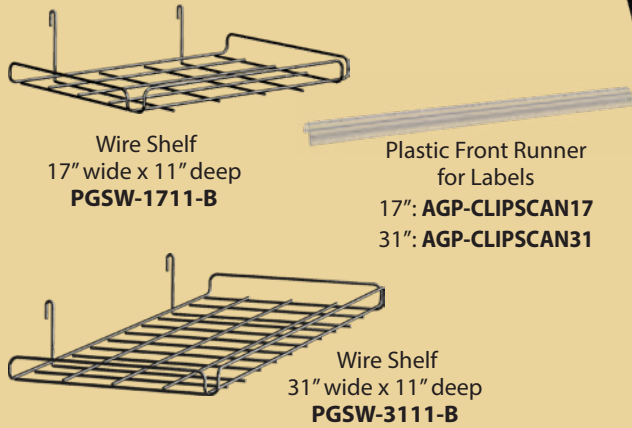

18" x 60" PowerGrid™
with 3" grid spacing
With Casters
PG-1860C-3-B
With Levelers
PG-1860L-3-B

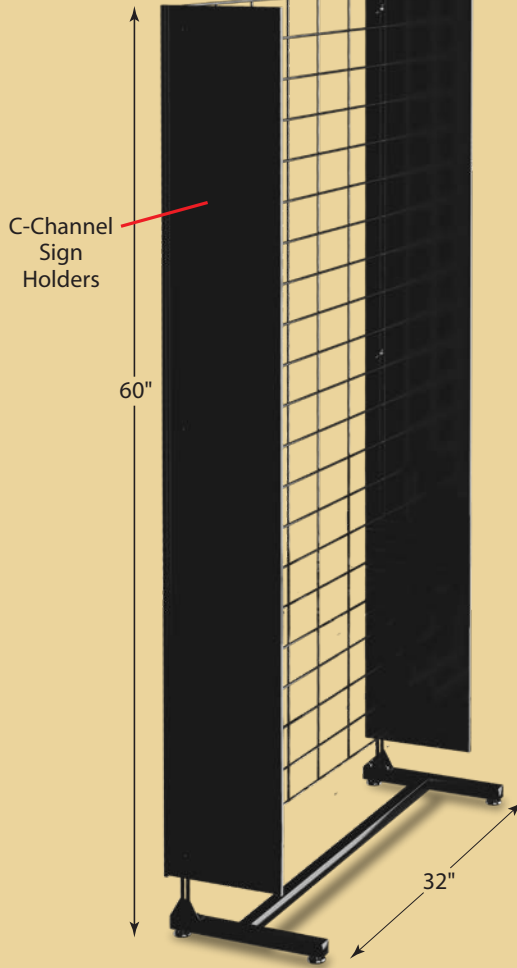

32" x 60" PowerGrid™
with 3" grid spacing
With Casters
PG-3260C-3-B
With Levelers
PG-3260L-3-B



Transformer Series

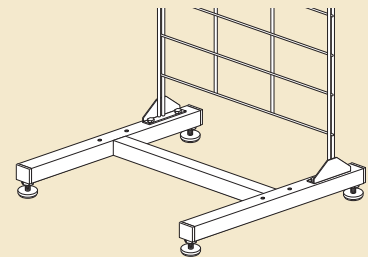

Rear Mount Grid
for 1-Sided Floor Display

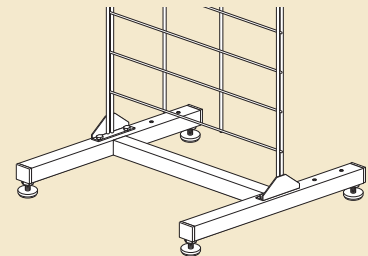

Center Mount Grid
for 2-Sided Floor Display

Base Supports



Locking Casters

Foot Levels



Power Platforms

ON THE FLOOR
Power Platforms



Lane Blockers & Checkout Lane Extenders



Perimeter Placement and Drive Aisles

Create new high profile sales/profit centers

- Power Platforms create extra selling space down power drive aisles, perimeter race track, entrances and check-out areas.
- Ideal for cross merchandising private labels, national brands, food and non-food products.
- "Lego-system" feature offers a uniform look to accommodate pegged, bottled, boxed and bulk product.
- Create additional 16 sq. ft. of merchandising 2-sided selling space.
- Power Platform is 51" tall with 24"x 48" pegboard and metal frame with four locking casters.
- Power Platforms are shipped assembled.
- Optional accessories include peg hooks, shelves and bulk dump bins.
- Custom die cut signs can be added to match your store decor or brand graphics.

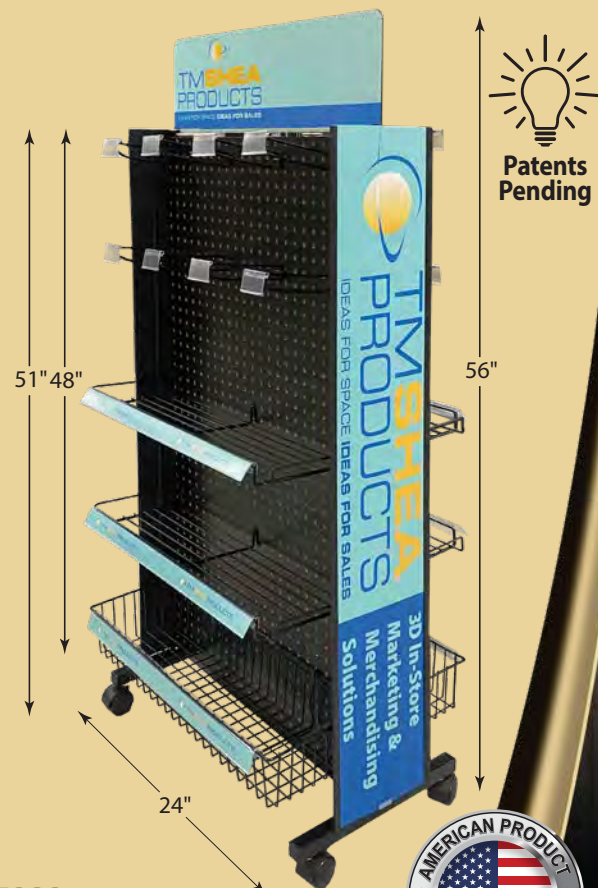

800.992.5233
email: hq@tmshea.com
www.tmshea.com



Power Platforms

ON THE FLOOR
Power Platforms

Metal Peg Hooks



4" Metal Peg Hook
MPWP-4-B

6" Metal Peg Hook
MPWP-6-B

8" Metal Peg Hook
MPWP-8-B



4" Metal Peg Hook with Flip Scan
MPWP-4S-B

6" Metal Peg Hook with Flip Scan
MPWP-6S-B

8" Metal Peg Hook with Flip Scan
MPWP-8S-B

Pegboard Shelves and Wire Baskets

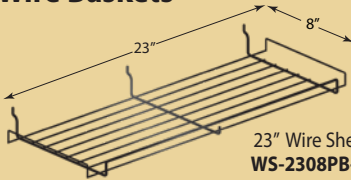

23" Wire Shelf
WS-2308PB-B

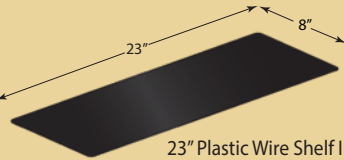

23" Plastic Wire Shelf Insert
(Optional)

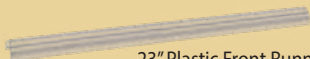

23" Plastic Front Runner for Labels
AGP-CLIPSCAN23

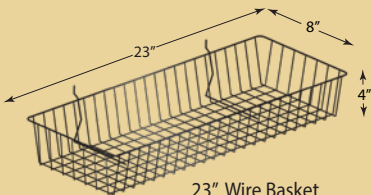

23" Wire Basket
PGB-23X8X4-B

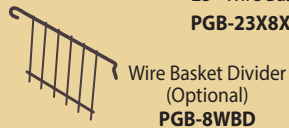

Wire Basket Divider
(Optional)
PGB-8WBD

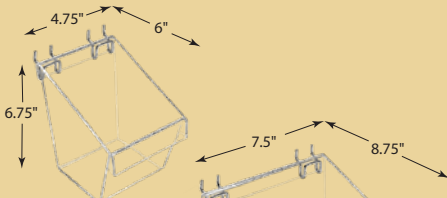

4.75" x 6.5" x 6.75"
PWP-PDB-4x6

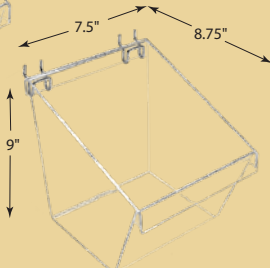

7.5" x 8.75" x 9"
PWP-PDB-7x8



Patents Pending

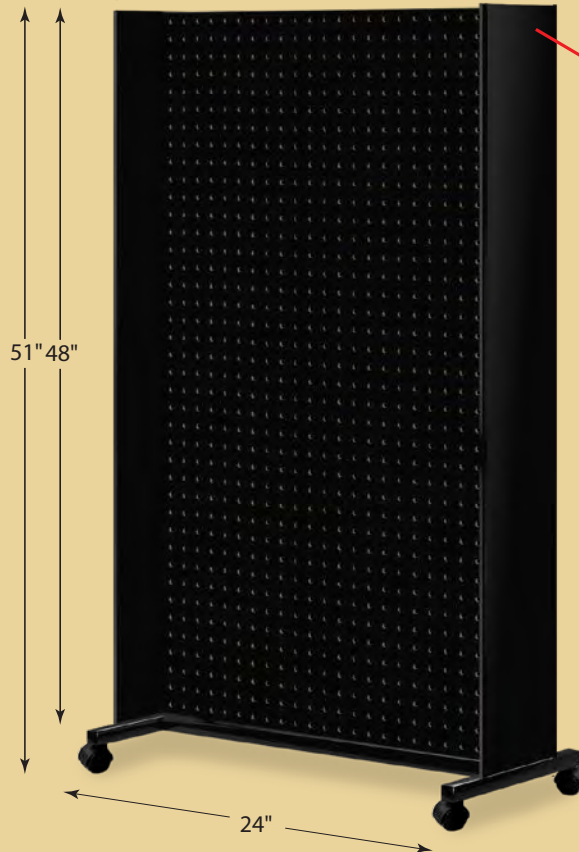

C-Channel Sign Holders
8"x48"

24"x 51" PowerPlatform
with Locking Casters
PPF-2451-C
with Foot Levelers
PPF-2451-FT

Base Supports



Locking Casters



Foot Levels



Top Rail Mount ArcArms™

IN THE AIR
Top Rail Mount ArcArms™



Parallel Sign System



Perpendicular Sign System

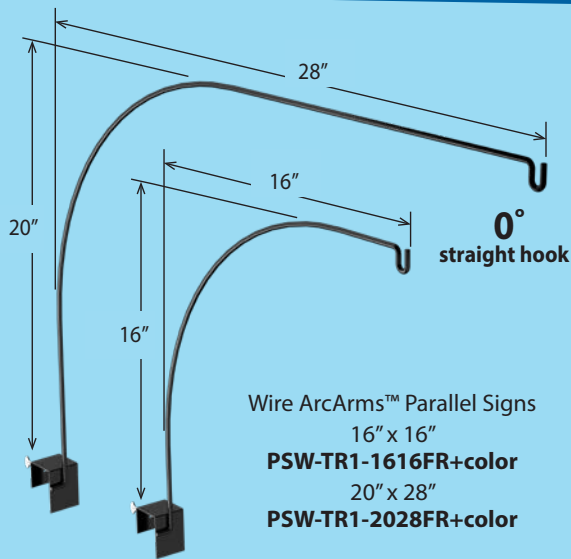

Wire ArcArms™ Parallel Signs
16" x 16"
PSW-TR1-1616FR+color
20" x 28"
PSW-TR1-2028FR+color

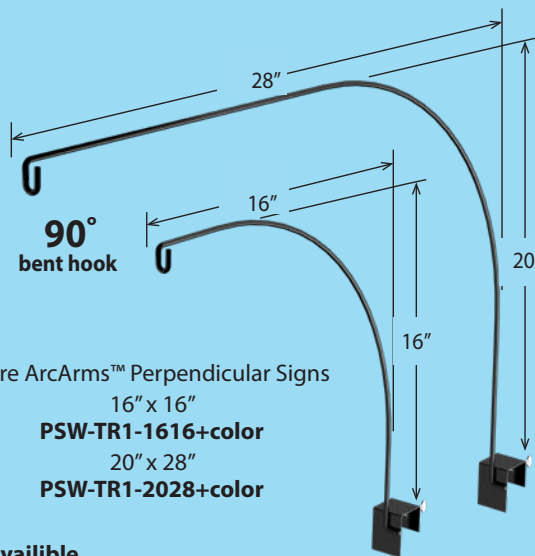

Wire ArcArms™ Perpendicular Signs
16" x 16"
PSW-TR1-1616+color
20" x 28"
PSW-TR1-2028+color

Custom colors available



Patents Pending

Custom Sign Shapes Printed on Rigid Substrates

Call us for details!

- Highlight private label benefits
- Promotes to CPG brands
- Advertise new products
- Promotional marketing messaging
- Easy, fast installation
- Low cost with big impact

Shelf Edge Sign System

IN THE AIR
Shelf Edge Sign System



Mounts to shelf edge



Parallel Sign Holder System



Mounts to shelf edge



Perpendicular Sign Holder System

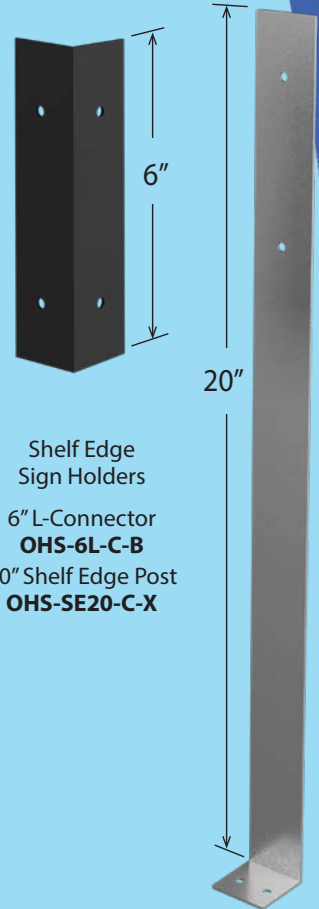

Shelf Edge Sign Holders
6" L-Connector
OHS-6L-C-B
20" Shelf Edge Post
OHS-SE20-C-X

Custom colors available



Custom Sign Shapes
Printed on Rigid Substrates

Call us for details!

- Private label/Brand signs
- Marketing messaging
- Category signs
- Easy, fast installation
- Low cost with big impact
- Custom colors available



1-800-992-5233
E-mail: hq@tmshea.com
www.tmshea.com



TMSHEA PRODUCTS

IDEAS FOR SPACE IDEAS FOR SALES

New Designs Summer 2023 Impulse Cross Merchandising Display Solutions



CAPTURE "UNUSED WHITE SPACE" • CREATE NEW SALES AND PROFITS

for more details, samples and pricing contact
**Tom Shea at HQ@tmshea.com or
call (800)992-5233**



 **TMSHEA
PRODUCTS**
1950 Austin Drive , Troy, MI 48083
www.TMSHEA.com

Who We Are

- T.M. Shea Products, Inc. is proud to be celebrating our 40th year anniversary.
- We design and make creative point-of-purchase display fixtures, print signs and kit pack for warehouse and drop shipping stores.
- An industry leader in design and development of highly effective and visually appealing impulse P.O.P. displays for 'white space'.
- Many standard P.O.P. display programs we offer can also be custom fabricated to meet your specific needs.
- You will find our catalogs, marketing brochures and our new website (coming soon) very informative and packed with exciting new in-store marketing strategies.
- We offer many solutions for driving incremental sales and profits with merchandising flexibility.
- over 60 issued U.S. patents with many more patents pending.

How We Work for You...

- Explore and discover all the new P.O.P. display product lines for impulse/promotional cross merchandising display solutions.
- We are offering displays that capture unused 'white air space' in the stores and/or have improved on the current displays already in the stores.
- T.M. Shea Products, Inc. can supply you many stock designs, create variations of current designs or design, engineer and fabricate custom displays.
- We offer sign design with printing services and can kit pack all displays, even pack-out with CPG products for warehouse or store drop shipping.
- TM Shea can help support your GM/HBC candy, meat/seafood, grocery, dairy, deli/bakery and produce categories with more sales opportunities.

Results and Benefits We Deliver....

- Proven success with many retail chains, distributors, national and specialty brands.
- T.M. Shea Products, Inc. will deliver new found permanent, promotional, rotational selling space throughout the store thereby increasing merchandising flexibility.
- Supply displays for first-to-market new product launches, seasonal sales, in-line impulse and cross merchandising shopper solutions.
- Increase overall sales, average sale/sq. ft.(inch) and average sales/shopper.
- By adding many new promotional touch points and promos your customers will increase their loyalty and shopping frequency.

Fresh new displays, for fresh new shopper solutions, delivering fresh new sales!



Adjustable 5-Shelf Rolling Rack

Vendor No. 3060513



*Perfect for Displaying
A Combination of
Assorted products*

This heavy-duty 5-shelf display works great for produce, bakery, deli and other fresh perimeter locations. Shelves adjust in 2" increments for merchandising flexibility. A very durable, and strong design built to last a long time.

- 5 metal adjustable wire shelves
- Built in data strips for UPC shelf tags and branded printed strips
- Promotional changeable 4 color printed signage for the sides
- Adjustable foot levelers or locking casters

Available
Customized
PRINTED
PANELS

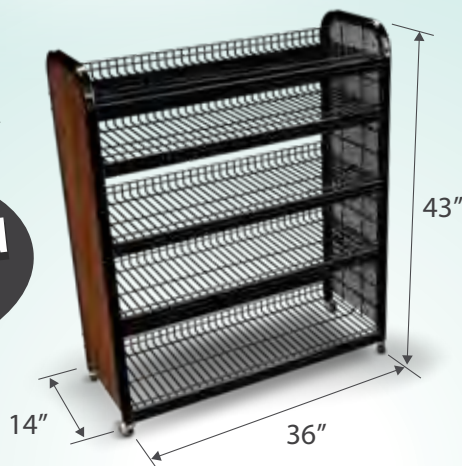

Power Platform Display



Creating New High Profile Sales and Profit Centers

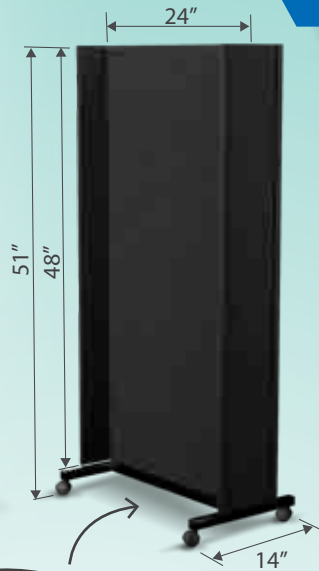

- Power Platforms the extra selling space in power drive aisles, perimeter race track, entrances and check-out areas
- Ideal for cross merchandising private labels, national brands, food and non-food products
- “Lego-system” feature offers a uniform look to accommodate pegged, bottled, boxed and bulk product
- Create additional 16 sq. ft. of merchandising 2-sided selling space
- Power Platforms are shipped assembled.
- Optional accessories include peg hooks, shelves and bulk dump bins

Available
Custom Printed
SIGNAGE



Monster PowerPanel Floor Displays

Make Your Endcap Sides Work Harder and Smarter for You!

On the side of end caps most powerpanels or wire wings are 14" x 48" compared to our 24" x 72" Monster power panels will give you almost 3x the selling space in the same footprint while delivering a huge lift in sales, profits and more shopper solutions. Perfect for cross merchandising candy, snacks, GM, HBC, private label and specialty items.

- 24" x 72" of selling space
- Flexible merchandising with 6" and 8" peg hooks, shelving and dump bins
- High profile locations for aisle and perimeter visibility
- Changeable custom printed graphics



Monster PowerPanel Suspended Displays

**Boost Your Endcap Side Sales
 And Merchandising Flexibility
 Far More Selling Space Than
 The Basic 14" X 48" Wing Panels**

The new Monster PowerPanel is perfect for impulse sales of GM/HBC, snack, candy specialty food items to private label, seasonal and price promos. This design suspends from our heavy duty arms that lock into the slotted end cap siderails, keeps the display in the air and off the floor. Very robust and durable construction to last many years. Easy assembly and installs fast.

- High visibility on the side of end caps
- 3 Sizes - 18" x 48" / 18" x 60" / 24" x 60"
- Variety of 6" and 8" peg hooks, shelving and dump bins
- Plastic side sign channels
- Heavy duty suspension arms
- Custom printed sign graphics

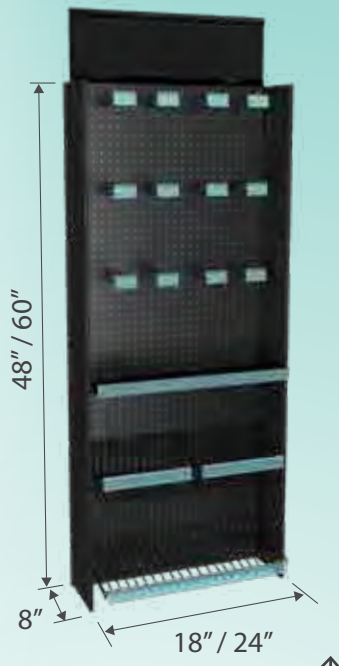

Available
Customized
 PRINTED
 PANELS



Low Profile PowerGrid Impulse Displays



Short and Sweet Cross Merchandising

Available in many widths and sizes to fit under coolers, meat/seafood service counters, side of bunkers, deli, bakery, and under or next to the produce counters/bins. Ideal design and function for cross merchandising related and new items.

- Mix and Match desirable related items for impulse sales
- Low profile look with a big impact
- 6" and 8" peg hooks with both 8" and 12" deep shelving
- Welded C-channel for UPC shelf tags and branded printed strips
- Changeable custom printed side graphics
- Adjustable foot levelers or locking casters

POWERGRID SIZES

32" Wide	48" Wide
15" Tall	15" Tall
25" Tall	36" Tall
36" Tall	48" Tall
48" Tall	

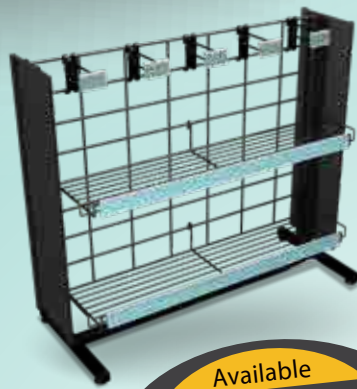

Available
Customized
PRINTED
PANELS



IN-STORE



12" x 48" Acrylic Shield Safety Extender

Protection for Your Staff and Your Customers

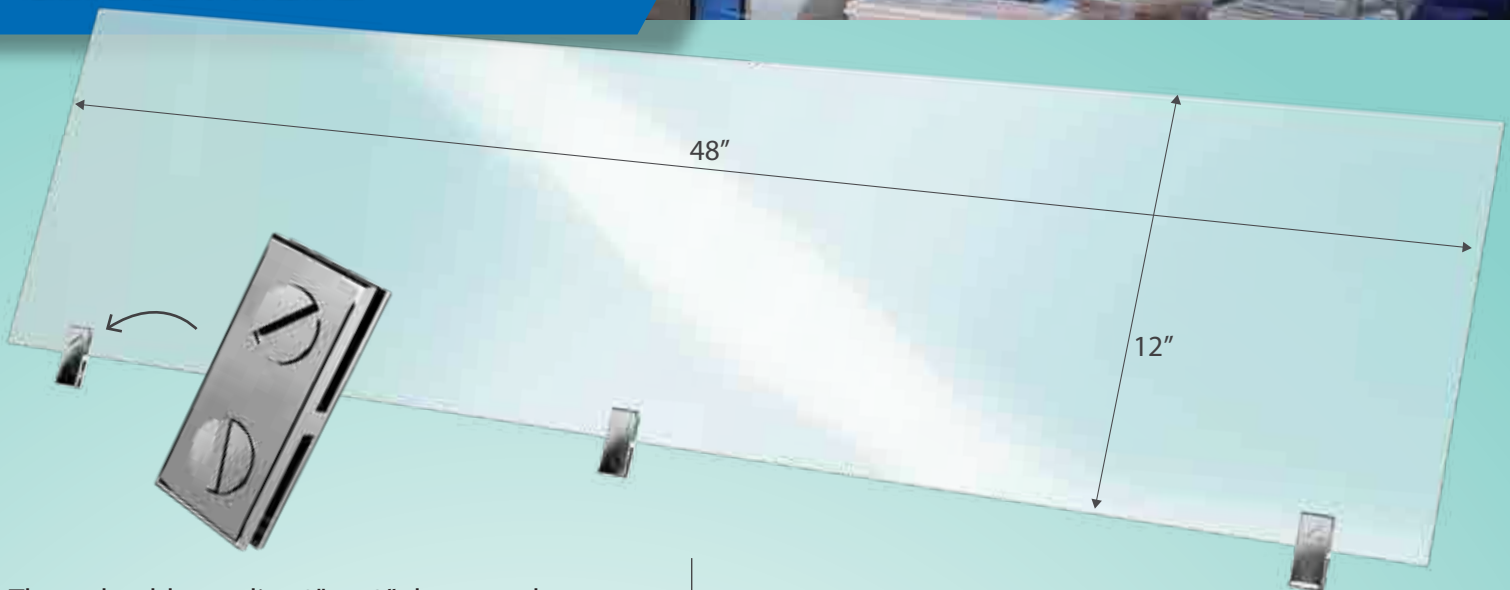

These durable acrylic 12" x 48" clear panels mount easily with our unique 2-way clamp system for securing safely to the glass partition barriers. Currently the glass is too low and shoppers reach in drop items/ talk or cough above the glass and contaminates the fresh seafood, we now can prevent this from happening.

- 3 Mounting joining clips per panel
- Acrylic 12" x 48" safety extenders
- Prevents the spread of germs
- Easy to assemble



Gift Card Displays in Greeting Card Department



**Secondary Displays
 Help Stimulate
 Additional Sales**

Available
 welded
**Metal & Plastic
 HOOKS**

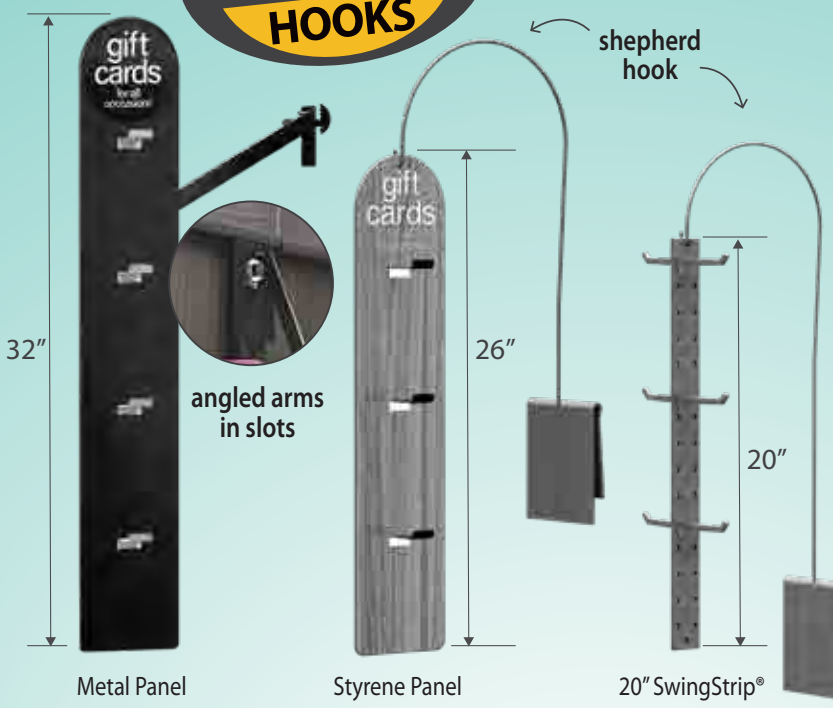

Getting your Kroger gift cards and 3rd party mall gift cards in the greeting card dept will give you more sales for both greeting cards and gift cards. They might also seek out the main gift card display to buy more or different cards for themselves or others. We offer many display designs to choose from for your stores.

- Double sided display offers 4 card facing/side
- Universal mounting brackets for card pockets or slots
- Short metal peg hooks welded to the metal panel
- Custom printing options
- SwingStrip® and SwingPanel™ options
- Variety of mounting brackets



72" x 7" Heavy Duty Bunker Bridge

A Robust and Sleek Looking Display for Add on Sales Over Frozen Bunkers



- 2 Sizes available: 28" x 7" standard and 72" x 7" HD Bunker Bridge
- Adjustable arms to accommodate all bunkers
- Rubber dipped anti-slip mounting brackets
- 3" Fencing to protect product from falling off
- Holds 4 cases 48 bottles
- Great for wine, condiment, and other related items



Counter Rack for Cross Merchandising on Meat/Seafood Counters

Vendor No. 3060513



Perfect Flavor Pairing for Partnering with Meat and Seafood



Take advantage of this eye-catching display for full service fresh meat and seafood counters or place it in the perimeter wall meat shelving. Small and convenient, this display will always offer the perfect fit for cross merchandising products.

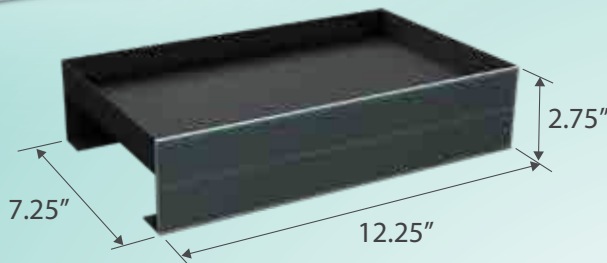

- Mix and match desirable related items for impulse sales
- Small foot print of 12" x 7" with a big impact
- 2- Built in data strips for UPC shelf tags and printed flavor/brand strips
- Non-slip rubber feet



Under Shelf SwingStrips® - End Cap Corners

Vendor No. 3060513



Make Products Stand Out



- Proven to out-sell traditional disposable plastic strips and J-hooks
- SwingStrips® are made of extruded plastic in standard lengths of 20, 30 and 60 inches
- Peg hooks faces out products nicely -easy to shop easy and reload
- Available in stock ivory or special order white, black or gray
- Peg hooks are available in a variety of styles and lengths of 1- 4 inches with or without UPC label holders



Wine Tower 12-level 24 Bottles

Vendor No. 3060513

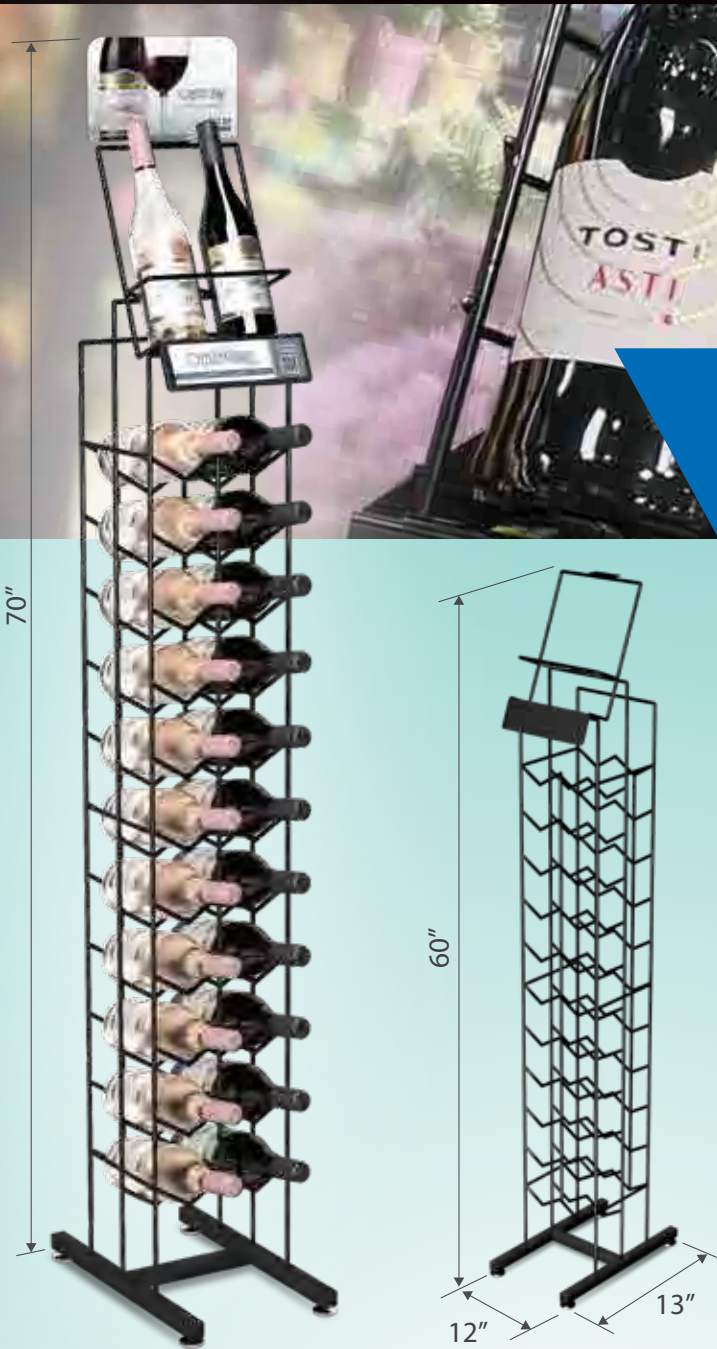

Taking Wine Racks to the Next Level

A beautifully designed permanent, durable and stable metal wine tower display holds 2 cases/24 bottles of most wine and champagne bottles. Perfect for placement in floral, meat/seafood, produce, bakery, deli, seasonal, greeting card, and in-line for featured new wines.

- Small 12" x13" footprint
- 12 Levels 24 bottles
- 7" x11" detachable optional promo sign frame
- Data strip for UPC shelf tags or printed brand graphics
- Adjustable foot levelers
- Ships fully assembled



KneeKnocker 2-Level Wine Display 48 Bottles



A Great Way to Promote Cross Merchandise Wine and More!

A low profile display designed to fit perfectly for impulse sales in small locations such as the side of frozen bunkers, under the fresh meat/seafood counters, deli, bakery and produce areas. Visually appealing, strong and durable this KneeKnocker display is built to last with 1" tube, all metal construction. Classic design, ready to go and get to work selling for you.

- Holds 48 wine or champagne bottles
- Also ideal for condiments and other related items
- Shelves have data strips for UPC shelf tags and branded print strips
- Promotional magnetic side signs are optional
- Foot levelers or locking casters

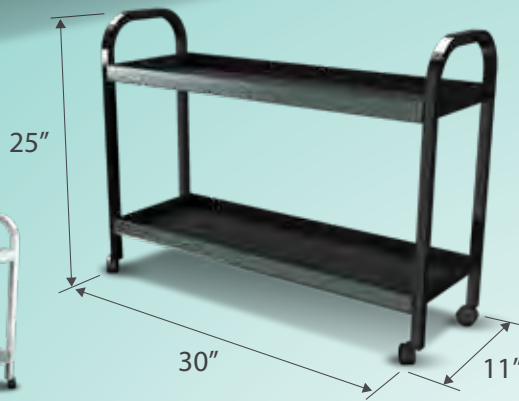

Also available in silver



IN-STORE



PowerWing™ Sign Package

Vendor No. 3060513



CREATE NEW OR RETROFIT EXISTING WIRE WING PANELS



- Plastic extruded sign channels mount to front of PowerWings™
- Choose from rear mounted sign frames or front mounted sign channels for headers
- P.O.P. graphics on header and side panels can be changed out
- Attach PowerWings™ to end cap side rail
- Use with a variety of metal grid hooks and shelves
- All mounting brackets come with appropriate hardware for installation
- Custom grid sizes and colors are available
- We supply the wire wing panels in variety colors

